

AT	BE	BG	CZ	CY	DE	DK
ES	FI	FR	GR	HU	IE	IT
LT	LU	LV	MT	NL	PL	PT
RO	SE	SI	SK	UK		

CE **!** DICHIARAZIONE DI CONFORMITÀ
(in conformità con ISO/IEC 17050-1)

No. HH2012101101

Prodotto/i: VTR Kalahari 4WD Desert Raider RTR 1/14

Numero(i) articolo: VTRO10011

Classe dei dispositivi: 2

Gli oggetti presentati nella dichiarazione sopra citata sono conformi ai requisiti delle specifiche elencate qui di seguito, seguendo le disposizioni della direttiva europea ARTT 1999/5/EC, CEM direttiva 2004/108/EC y LVD 2006/95/EC:

EN 300-328 V1.7: 2006

EN 301 489-1 V1.7: 2006

EN 301 489-17 V1.3.2: 2008

EN 60950-1:2006+A12: 2011

EN55022: 2010

EN55024: 2010

EN61000-3-2:2006+A1:2009+A2:2009

EN61000-3-3:2008

Firmato per conto di:

Horizon Hobby, Inc.

Champaign, IL USA

11 ottobre 2012

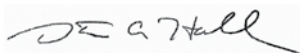

Steven A. Hall

Executive Vice President and Chief Operating Officer





International Operations and Risk Management

Horizon Hobby, Inc.



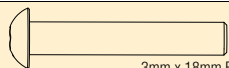
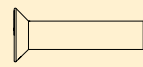
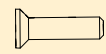

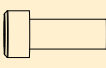





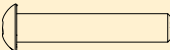
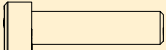
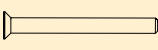
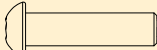
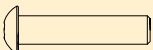
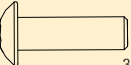
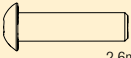
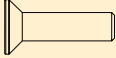
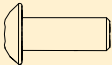
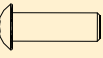









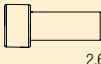





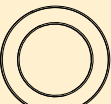
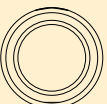



SMALTIMENTO ALL'INTERNO DELL'UNIONE EUROPEA

Questo prodotto non deve essere smaltito assieme ai rifiuti domestici. Invece è responsabilità dell'utente lo smaltimento di tali rifiuti, che devono essere portati in un centro di raccolta designato per il riciclaggio di rifiuti elettronici. Con tale procedimento si aiuterà preservare l'ambiente e le risorse non verranno sprecate. In questo modo si proteggerà il benessere dell'umanità. Per maggiori informazioni sui punti di riciclaggio si prega di contattare il proprio ufficio locale o il servizio di smaltimento rifiuti.

	x 4
3mm x 18mm Button Head Screw 3mm x 18mm Halbrundschraben Vis à tête bombée 3mm x 18mm Viti testa tonda 3mm x 18mm	
	x 6
2.6mm x 12mm Flat Head Screw 2,6mm x 12mm Flachkopfschrauben Vis à tête fraisée 2,6mm x 12mm Viti a testa piatta 2,6mm x 12mm	
	x 2
2mm x 8mm Flat Head Screw 2mm x 8mm Flachkopfschrauben Vis à tête fraisée 2mm x 8mm Viti a testa piatta 2mm x 8mm	
	x 2
2.6mm x 7mm Flat Head Screw 2,6mm x 7mm Flachkopfschrauben Vis à tête fraisée 2,6mm x 7mm Viti a testa piatta 2,6mm x 7mm	
	x 2
3mm x 8mm Cap Head Screw 3mm x 8mm Innensechskantschrauben Vis à tête creuse 3mm x 8mm Viti a testa bombata 3mm x 8mm	
	x 2
Pivot Ball Kugelkopf Rotules Dadi a sfera	
	
4mm x 7mm x 2.5mm Ball Bearing 4mm x 7mm x 2,5mm Kugellager Roulement 4mm x 7mm x 2,5mm Cuscinetto a sfere 4mm x 7mm x 2,5mm	

VERBINDUNGSELEMENTE // ATTACHES // ELEMENTI DI FISSAGGIO

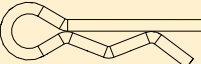
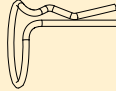
 x 2 2.6mm x 14mm Button Head Screw 2,6mm x 14mm Halbrundschräuben Vis à tête bombée 2,6mm x 14mm Viti testa tonda 2,6mm x 14mm	 x 4 3mm x 12mm Cap Head Screw 3mm x 12mm Innensechskantschrauben Vis à tête creuse 3mm x 12mm Viti a testa bombata 3mm x 12mm	 x 6 1.4mm x 14mm Flat Head Screw 1,4mm x 14mm Flachkopfschrauben Vis à tête fraisée 1,4mm x 14mm Viti a testa piatta 1,4mm x 14mm	 x 10 3mm x 12mm Button Head Screw 3mm x 12mm Halbrundschräuben Vis à tête bombée 3mm x 12mm Viti testa tonda 3mm x 12mm	 x 2 2.6mm x 12mm Button Head Screw 2,6mm x 12mm Halbrundschräuben Vis à tête bombée 2,6mm x 12mm Viti testa tonda 2,6mm x 12mm
 x 4 3mm x 10mm Button Head Screw 3mm x 10mm Halbrundschräuben Vis à tête bombée 3mm x 10mm Viti testa tonda 3mm x 10mm	 x 4 2.6mm x 10mm Button Head Screw 2,6mm x 10mm Halbrundschräuben Vis à tête fraisée 2,6mm x 10mm Viti testa tonda 2,6mm x 10mm	 x 12 2.6mm x 10mm Flat Head Screw 2,6mm x 10mm Flachkopfschrauben Vis à tête bombée 2,6mm x 10mm Viti a testa piatta 2,6mm x 10mm	 x 5 3mm x 8mm Button Head Screw 3mm x 8mm Halbrundschräuben Vis à tête fraisée 3mm x 8mm Viti testa tonda 3mm x 8mm	 x 16 2.6mm x 8mm Button Head Screw 2,6mm x 8mm Halbrundschräuben Vis à tête bombée 2,6mm x 8mm Viti testa tonda 2,6mm x 8mm
 x 4 2.6mm x 8mm Flat Head Screw 2,6mm x 8mm Flachkopfschrauben Vis à tête fraisée 2,6mm x 8mm Viti a testa piatta 2,6mm x 8mm	 x 2 2.6mm x 8mm Flat Head Screw 2,6mm x 8mm Flachkopfschrauben Vis à tête fraisée 2,6mm x 8mm Viti a testa piatta 2,6mm x 8mm	 x 1 3mm x 6mm Button Head Screw 3mm x 6mm Halbrundschräuben Vis à tête bombée 3mm x 6mm Viti testa tonda 3mm x 6mm	 x 4 1.4mm x 6mm Cap Head Screw 1,4mm x 6mm Innensechskantschrauben Vis à tête creuse 1,4mm x 6mm Viti a testa bombata 1,4mm x 6mm	 x 10 2.6mm x 6mm Button Head Screw 2,6mm x 6mm Halbrundschräuben Vis à tête bombée 2,6mm x 6mm Viti testa tonda 2,6mm x 6mm
 x 1 3mm x 6mm Flat Head Screw 3mm x 6mm Flachkopfschrauben Vis à tête fraisée 3mm x 6mm Viti a testa piatta 3mm x 6mm	 x 2 2mm x 6mm Flat Head Screw 2mm x 6mm Flachkopfschrauben Vis à tête fraisée 2mm x 6mm Viti a testa piatta 2mm x 6mm	 x 6 2.6mm x 6mm Flat Head Screw 2,6mm x 6mm Flachkopfschrauben Vis à tête fraisée 2,6mm x 6mm Viti a testa piatta 2,6mm x 6mm	 x 3 M3 Set Screw M3 Gewindestift Vis Imbus M3 Grani M3	 x 1 2.6mm x 8mm Cap Head Screw 2,6mm x 8mm Innensechskantschrauben Vis à tête creuse 2,6mm x 8mm Viti a testa bombata 2,6mm x 8mm
 x 1 2.6mm x 6mm Flanged Button Head Screw 2,6mm x 6mm Halbrundschräuben angeflanscht Vis à tête bombée bride 2,6mm x 6mm Viti testa tonda flangiato 2,6 x 6mm	 x 4 2.6mm x 8mm Cap Head Screw 2,6mm x 8mm Innensechskantschrauben Vis à tête creuse 2,6mm x 8mm Viti a testa bombata 2,6mm x 8mm	 x 4 2.6mm x 8mm Flat Head Screw 2,6mm x 8mm Flachkopfschrauben Vis à tête fraisée 2,6mm x 8mm Viti a testa piatta 2,6mm x 8mm	 x 12 Ball Stud Kugelenbolzen Goujon à rotule Perno della sfera	 x 8 Pivot Ball Kugelkopf Rotules Dadi a sfera
 x 4 10mm x 15mm x 4mm Ball Bearing 10mm x 15mm x 4mm Kugellager Roulement 10mm x 15mm x 4mm Cuscinetto a sfere 10mm x 15mm x 4mm	 x 4 8mm x 12mm x 3,5mm Ball Bearing 8mm x 12mm x 3,5mm Kugellager Roulement 8mm x 12mm x 3,5mm Cuscinetto a sfere 8mm x 12mm x 3,5mm	 x 1 7mm x 11mm x 3mm Ball Bearing 7mm x 11mm x 3mm Kugellager Roulement 7mm x 11mm x 3mm Cuscinetto a sfere 7mm x 11mm x 3mm	 x 4 4mm x 10mm x 3mm Ball Bearing 4mm x 10mm x 3mm Kugellager Roulement 4mm x 10mm x 3mm Cuscinetto a sfere 4mm x 10mm x 3mm	 x 3 5mm x 9mm x 3mm Ball Bearing 5mm x 9mm x 3mm Kugellager Roulement 5mm x 9mm x 3mm Cuscinetto a sfere 5mm x 9mm x 3mm
 x 4 M3 Locknut M3 Stopmuttern Ecrous freinés M3 Dado autobloccante M3	 x 4 M3 Locknut M3 Muttern Ecrous freinés M3 Dado autobloccante M3	 x 4 M3 Nut M3 Muttern Ecro M3 Dado M3	 x 4 M2.5 Locknut M2.5 Stopmuttern Ecrous freinés M2.5 Dado autobloccante M2.5	 x 1 M4 Locknut M4 Stopmuttern Ecrous freinés M4 Dado autobloccante M4
 x 1 Wave Washer Wellenscheibe Rondelle ondulée Rondella ondulata	 x 3 Tooth Washer Zahnscheibe Rondelle dent Dente rondella	 x 8 E-Clip E-Clip E-Clip E-Clip	 x 4 Body Clips Gehäuseclips Clips carrosserie Clips del corpo	 x 2 Battery Clip Batterieclip Clip de la batterie clip di batteria

REPLACEMENT PARTS // ERSATZTEILE // PIÈCES DE RECHANGE // PEZZI DI RICAMBIO //

Part # Nummer Numéro Codice	Description	Beschreibung	Description	Descrizione
DYN4117	10W Ni-MH AC Peak Charger	Dynamite 10W Ni-MH AC Peak Ladegerät	Chargeur AC automatique Dynamite 10W	Caricatore rapido Dynamite 10W Ni-MH AC
DYN4830	Fuze 280 4500Kv Mini Sensorless Brushless Motor	Dynamite Fuze 280 4500Kv Mini Sensorloser Brushless Motor	Mini moteur brushless sensorless Dynamite Fuze 280 4500Kv	Motore brushless Dynamite Fuze 280 4500Kv Mini Sensorless
DYN4840WP	Fuze Mini Waterproof Sensorless Brushless ESC	Dynamite Fuze Mini Spritzwassergeschützter Sensorloser Brushless Regler	Mini contrôleur brushless sensorless étanche Dynamite Fuze	Regolatore (ESC) Dynamite Fuze Mini Waterproof Sensorless Brushless
DYN1473	7.2V 1200mAh 6C Ni-MH Battery	Dynamite 7.2V 1200mAh 6C Ni-MH Akkut	Batterie Ni-Mh Dynamite 7.2V 1200mA	Batteria Dynamite 7.2V 1200mAh 6C Ni-MH
SPMSR200WP	SR200WP 2-Channel DSM Waterproof Sport Receiver	Spektrum SR200WP 2-Kanal DSM spritzwassergeschützter Sport Empfänger	Récepteur 2 voies étanche SR200WP DSM Spektrum	Spektrum SR200WP ricevitore impermeabile 2-canali DSM
SPMR2400	DX2L DSM 2-Channel Surface Radio	Spektrum DX2L 2.4GHz DSM Fernsteuerung	Radio Spektrum DX2L 2.4GHz DSM	Radiocomando Spektrum DX2L 2.4GHz DSM
VTR11000	903WP Digital Servo	903WP Servo	Servo 903WP	903WP Servo

TIRE & WHEEL // REIFEN UND RAD // PNEU AVEC JANTE // GOMME E CERCHI //

Part # Nummer Numéro Codice	Description	Beschreibung	Description	Descrizione
VTR41001	FR/RR Desert Spec Tire, Mounted	Deser Spec Reifen auf Felge montiert v/h	Pneu Av/Arr pour Desert, monté sur jante	Gomme spec Desert, montate



ASSEMBLY // MONTAGE // ASSEMBLAGE // MONTAGGIO //////////////////////////////////////

Part # Nummer Numéro Codice	Description	Beschreibung	Description	Descrizione
DYN4840WP	Dynamite Mini BL Waterproof ESC	Dynamite spritzwasserdichter Sensorloser Brushless Regler	Contrôleur brushless sensorless Dynamite	Dynamite ESC impermeabile Sensorless Brushless
SPMSR200WP	Spektrum SR200WP 2Ch DSM Sport Receiver Waterproof	Spektrum SR200WP 2-Kanal DSM spritzwassergeschützter Sport Empfänger	Récepteur 2 voies étanche SR200WP DSM Spektrum	Spektrum SR200WP ricevitore impermeabile 2-canali DSM
VTR211000	Chassis	Chassis	Châssis	Telaio
VTR211006	Body Posts (4)	Karosseriehalter (4)	Support de carrosserie (4)	Supporti carrozzeria (4)
VTR211009	FR Bumper Set	Stoßfängerset vorne	Pare choc avant	Supporti carrozzeria
VTR211104	Upper Deck and Support Set	Obere Chassisverstrebung	Platine supérieure et ensemble support	Set coperchio e supporto
VTR212004	Motor Mount and Adaptor Set	Motorhalter und Adapter Set	Support moteur et ensemble adaptateur	Set montante e adattatore del motore
VTR212008	Drive Shaft Set	Antriebsachse Set	Jeu d'arbres d'entraînement	Set di Trasmissione
VTR215000	Hardware Set	Hardware Set	Visserie	Set bulloni
VTR216002	Body Clips (10)	Karosserieklammern (10)	Clips à carrosserie (10)	Clips carrozzeria (10)

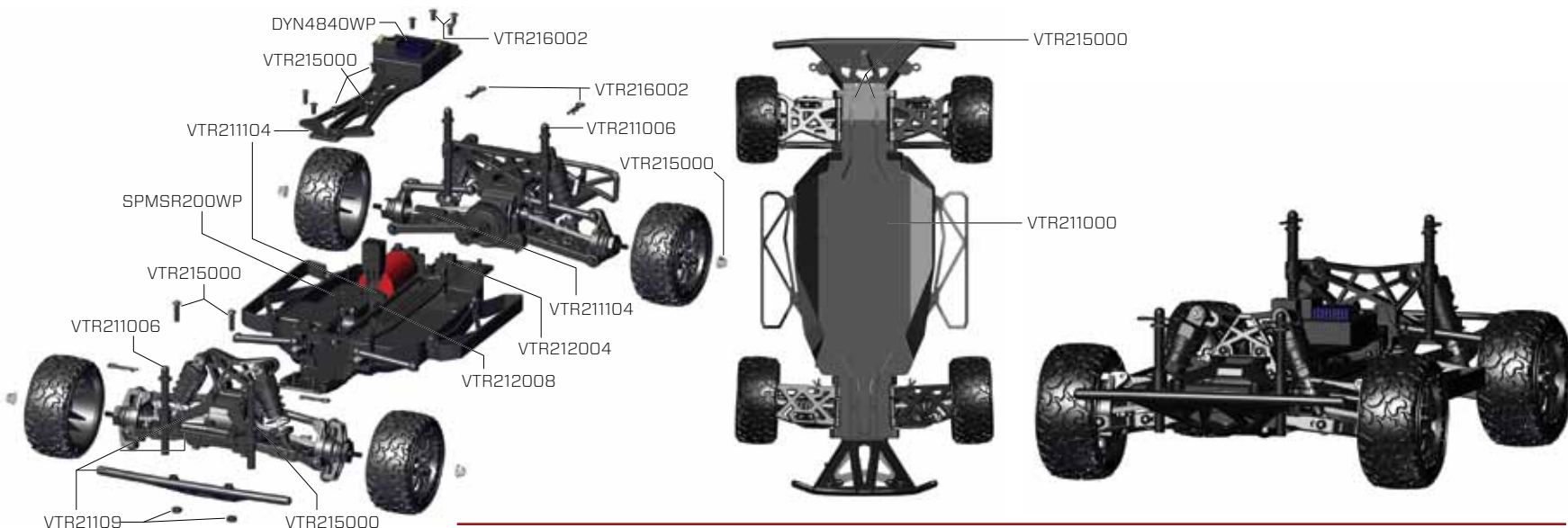

FRONT SUSPENSION // FRONT AUFHÄNGUNG // SUSPENSION AVANT // SOSPENSIONE ANTERIORE //

Part # Nummer Numéro Codice	Description	Beschreibung	Description	Descrizione
VTR212001	Wheel Hex Set (4)	Radschrauben Set (4)	Jeu d'écrous de roue (4)	Set dadi delle ruote (4)
VTR212007	Dog Bone Set (2)	Antriebsknochen Set (2)	Jeu de tiges à double rotule (2)	Set cardano (2)
VTR212009	Axle Set	Achsen Set	Jeu de fusées	Asse Set
VTR214002	Spindle, Hub, Carrier Set	Achsschenkelset Aluminium	Set de fusées en aluminium	Set perno, alluminio
VTR214003	Suspension Arm Set	Querlenker Set	Jeu de bras de suspension	Set bracci sospensioni
VTR214004	Suspension Mount Set	Querlenkerhalterset	Ensemble support de suspensions	Set montaggio sospensione
VTR214008	Suspension Bushing Set	Buchse für Querlenker	Jeu de bagues pour suspension	Set boccole sospensione
VTR215000	Hardware Set	Hardware Set	Visserie	Set bulloni
VTR216000	Ball Stud Set	Kugelkopfset	Jeu de rotules	Set perni sferici
VTR216001	Hinge Pin Set	Querlenkerstift Set	Jeu d'axes	Set perni cerniere
VTR217000	Ball Bearing Set	Kugellager Set	Jeu de roulements	Set cuscinetti a sfere



REAR SUSPENSION // HECK AUFHÄNGUNG // SUSPENSION ARRIÈRE // SOSPENSIONE POSTERIORE //////////////////////////////////////

Part # Nummer Numéro Codice	Description	Beschreibung	Description	Descrizione
VTR212001	Wheel Hex Set (4)	Radschrauben Set (4)	Jeu d'hexagones de roue (4)	Set dadi delle ruote (4)
VTR212007	Dog Bone Set (2)	Antriebsknochen Set (2)	Jeu de cardans (2)	Set cardano (2)
VTR212009	Axle Set	Achsen Set	Jeu de fusées	Asse Set
VTR214002	Spindle, Hub, Carrier Set	Achsschenkel, Radträgerset	Ensemble fusée/moyeu/porte-fusée	Albero, mozzo, porta-piastre
VTR214003	Suspension Arm Set	Querlenker Set	Jeu de bras de suspension	Set bracci sospensioni
VTR214004	Suspension Mount Set	Querlenkerhalterset	Ensemble support de suspensions	Set montaggio sospensione
VTR215000	Hardware Set	Hardware Set	Visserie	Set bulloni
VTR216000	Ball Stud Set	Kugelkopfset	Jeu de rotules	Set perni sferici
VTR216001	Hinge Pin Set	Querlenkerstift Set	Jeu d'axes	Set perni cerniere
VTR217000	Ball Bearing Set	Kugellager Set	Jeu de roulements	Set cuscinetti a sfere

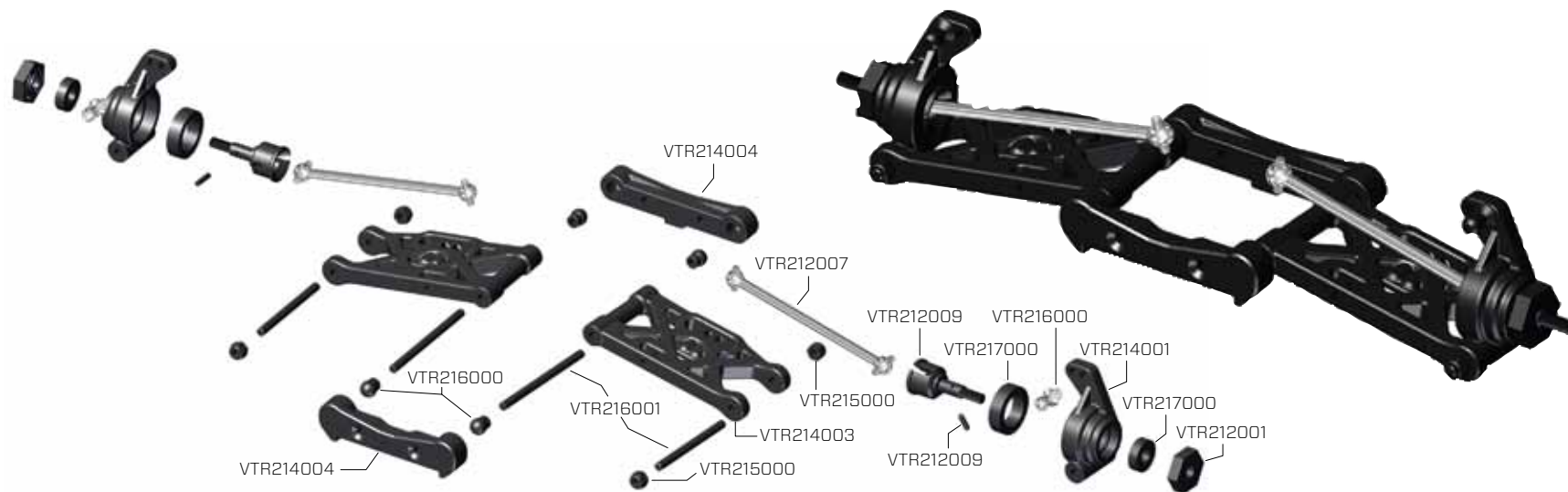

FRONT GEARBOX // GETRIEBEGEHÄUSE VORNE // BOÎTE DE TRANSMISSION AVANT ////////////////////////////////////// SCATOLA INGRANAGGI ANTERIORE

Part # Nummer Numéro Codice	Description	Beschreibung	Description	Descrizione
VTR211009	FR Bumper Set	Stoßfängerset vorne	Pare choc avant	Supporti carrozzeria
VTR212000	F/R Gearbox Set	Getriebegehäuse vorne/hinten	Carter de différentiel avant/arrière	Set scatola cambio anteriore
VTR212003	F/R Diff Gear, Housing and Spacer Set	Differential vorne/hinten m. Gehäuse Set	Ensemble engrenages, carter et bagues pour différentiel AV/AR	Ingranaggi differenziale anteriore/posteriore, set alloggiamento e distanziatore
VTR212008	Drive Shaft Set	Antriebsachse Set	Jeu d'arbres d'entraînement	Set albero di trasmissione
VTR212010	Diff Outdrive Set	Diff. Antriebsklauen Set	Jeu de noix de sortie de différentiel	Set bicchierino differenziale
VTR212011	Center Outdrive Set	Antriebsklauen Mitte	Jeu de noix de sortie centrale	Set bicchierino centrale
VTR213008	Shock Rebuild Set	Reparaturset f. Stoßdämpfer	Nécessaire de réparation d'amortisseur	Set ricondizionamento ammortizzatore
VTR214000	Front Shock Tower	Dämpferbrücke vorne	Support d'amortisseur avant	Torre ammortizzatore anteriore
VTR214006	Steering and Suspension Linkage Set	Anlenkenset für Lenkung/ Aufhängung	Jeu de biellettes de direction et de suspensions	Set collegamenti sterzo e sospensione
VTR215000	Hardware Set	Hardware Set	Visserie	Set bulloni
VTR216000	Ball Stud Set	Kugelkopfset	Jeu de rotules	Set perni sferici
VTR217000	Ball Bearing Set	Kugellager Set	Jeu de roulements	Set cuscinetti a sfere

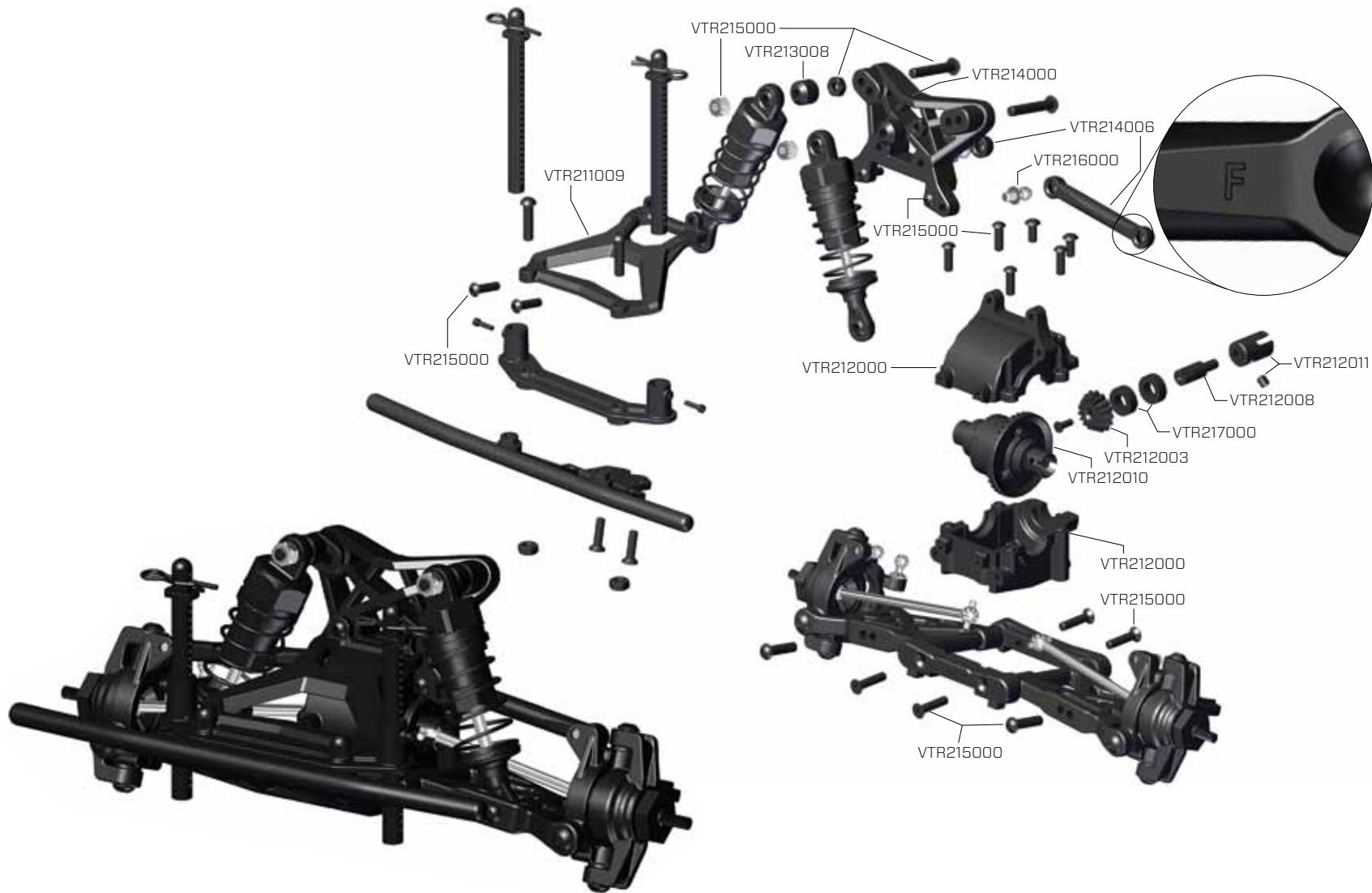

REAR GEARBOX // GETRIEBEGEHÄUSE HINTEN // BOÎTE DE TRANSMISSION ARRIÈRE ////////////////////////////////////// SCATOLA INGRANAGGI POSTERIORE

Part # Nummer Numéro Codice	Description	Beschreibung	Description	Descrizione
VTR211006	Body Posts (4)	Karosseriehalter (4)	Support de carrosserie (4)	Supporti carrozzeria (4)
VTR211010	RR Bumper Set	Stoßfängerset hinten	Pare choc arrière	Set paraurti poster
VTR212000	Front, Rear Gearbox Set	Getriebegehäuse vorne/hinten	Carter de différentiel avant/arrière	Set scatola cambio anteriore
VTR212010	Diff Outdrive Set	Diff. Antriebsklauen Set	Jeu de noix de sortie de différentiel	Set bicchierino differenziale
VTR213008	Shock Rebuild Set	Reparaturset f. Stoßdämpfer	Nécessaire de réparation d'amortisseur	Set ricondizionamento ammortizzatore
VTR214001	Rear Shock Tower	Dämpferbrücke hinten	Support d'amortisseur arrière	Torre ammortizzatore posteriore
VTR214004	Suspension Mount Set	Querlenkerhalterset	Ensemble support de suspensions	Set montaggio sospensione
VTR214006	Steering and Suspension Linkage Set	Anlenkenset für Lenkung/ Aufhängung	Jeu de biellettes de direction et de suspensions	Set collegamenti sterzo e sospensione
VTR215000	Hardware Set	Hardware Set	Visserie	Set bulloni
VTR216000	Ball Stud Set	Kugelkopfset	Jeu de rotules	Set perni sferici

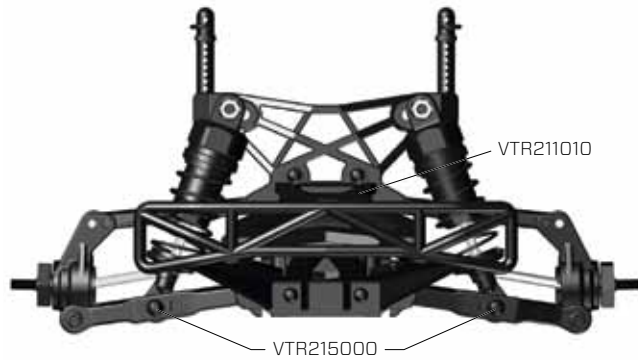

SHOCK ASSEMBLY // STOSSDÄMPFER // ASSEMBLAGE DES AMORTISSEURS // GRUPPO AMMORTIZZATORI //

Part # Nummer Numéro Codice	Description	Beschreibung	Description	Descrizione
VTR213000	Front Shock Body Set	Stoßdämpfergehäuse vorne	Jeu de corps d'amortisseur avant	Set corpo ammortizzatore anteriore
VTR213001	Rear Shock Body Set	Stoßdämpfergehäuse hinten	Jeu de corps d'amortisseur arrière	Set corpo ammortizzatore posteriore
VTR213002	Shock Piston Set	Stoßdämpferkolben Set	Jeu de pistons d'amortisseur	Set pistone ammortizzatore
VTR213003	Front Shock Spring Set	Federnsatz vorne	Jeu de ressorts d'amortisseur avant	Set molla ammortizzatore anteriore
VTR213004	Rear Shock Spring Set	Federnsatz hinten	Jeu de ressorts d'amortisseur arrière	Set molla ammortizzatore posteriore
VTR213005	Front Shock Shaft Set	Stoßdämpferkolbenstange Set v.	Jeu de tiges d'amortisseur avant	Set albero ammortizzatore anteriore
VTR213006	Rear Shock Shaft Set	Stoßdämpferkolbenstange Set h.	Jeu de tiges d'amortisseur arrière	Set albero ammortizzatore posteriore
VTR213007	Shock Retainer, Ball and Cap Set	Dämpferkappe mit Kugel Set	Jeu de chapes et rotules d'amortisseur	Fissaggio ammortizzatori, uniball e tappo ammortizzatore inferiore
VTR213008	Shock Rebuild Set	Reparaturset f. Stoßdämpfer	Nécessaire de réparation d'amortisseur	Set ricondizionamento ammortizzatore
VTR214007	O-ring Set	O-Ring Set	Jeu de joints toriques	Set O-ring

FRONT SHOCK // VORDERER STOSSDÄMPFER // AMORTISSEUR AVANT

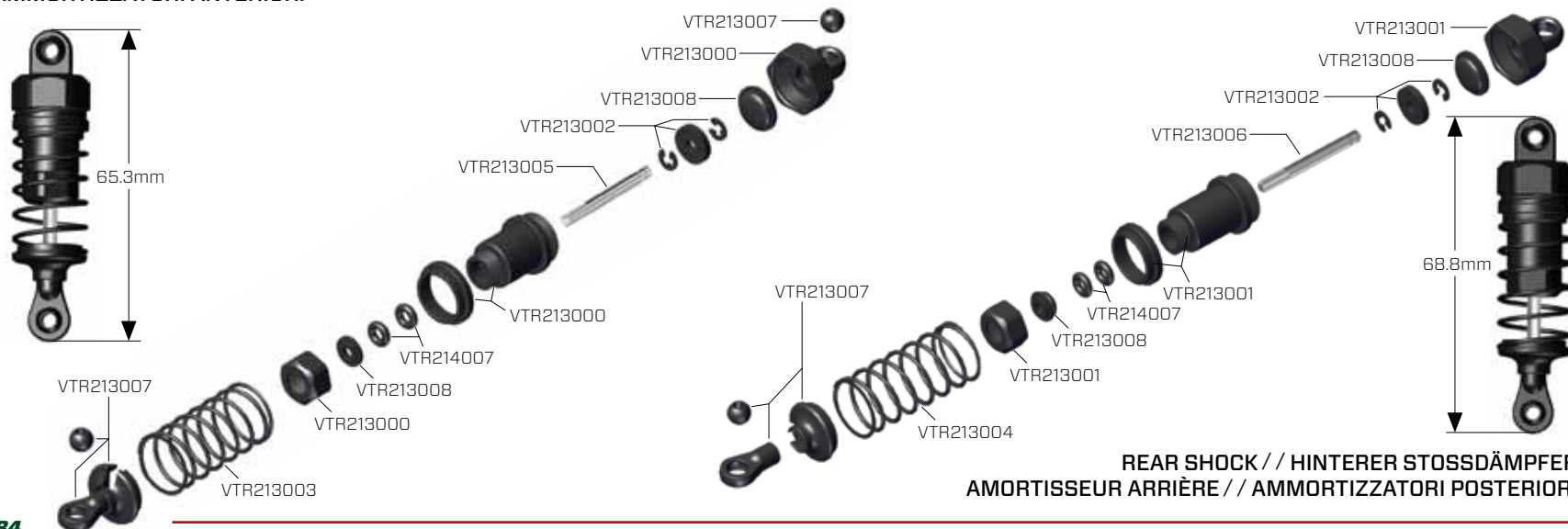

REAR SHOCK // HINTERER STOSSDÄMPFER // AMORTISSEUR ARRIÈRE // AMMORTIZZATORI POSTERIORI

GEAR TRAIN // GETRIEBE // MONTAGE DU SLIPPER // GRUPPO INGRANAGGI

Part # Nummer Numéro Codice	Description	Beschreibung	Description	Descrizione
VTR212002	Spur Gear Set (3)	Zahnräder Set (3)	Couronne (3)	Set ruota dentata cilindrica (3)
VTR212003	F/R Diff Gear, Housing and Spacer Set	Differential vorne/hinten m. Gehäuse Set	Ensemble engrenages, carter et bagues pour différentiel AV/AR	Ingranaggi differenziale anteriore/posteriore, set alloggiamento e distanziatore
VTR212005	Slipper Plate Set	Rutschkupplung Scheibe Set	Ensemble de plateaux pour le slipper	Set piastra pattino
VTR212006	Slipper Pad Set	Rutschkupplung Belag Set	Garnitures	Set pastiglie del pattino
VTR212008	Drive Shaft Set	Antriebsachse Set	Jeu d'arbres d'entraînement	Set albero di trasmissione
VTR212011	Center Outdrive Set	Antriebsklauen Mitte	Jeu de noix de sortie centrale	Set bicchierino centrale
VTR215000	Hardware Set	Hardware Set	Visserie	Set bulloni
VTR217000	Ball Bearing Set	Kugellager Set	Jeu de roulements	Set cuscinetti a sfere



CHASSIS // CHASSIS // CHÂSSIS // TELAIO //////////////////////////////////////

Part # Nummer Numéro Codice	Description	Beschreibung	Description	Descrizione
DYN4830	Dynamite Mini 4500KV BL Motor	Dynamite 4500Kv Mini Sensorloser Brushless Motor	Mini moteur brushless sensorless Dynamite 4500Kv	Motore brushless Dynamite 4500Kv Mini Sensorless
VTR11000	903WP Digital Servo	903WP Servo	Servo 903WP	903WP Servo
VTR211000	Main Chassis	Chassis	Châssis principal	Telaio principale
VTR211001	Nerf Guard Set	Seitenschutz	Jeu de protections latérales	Set protezione
VTR211002	Battery Hold Down Set	Akkualter Set	Ensemble de fixation des accus	Set per tenere la batteria
VTR211005	Steering Hardware Set	Lenkung Hardware Set	Visserie pour direction	Set bulloni sterzo
VTR211104	Upper Deck and Support Set	Obere Chassisverstrebung	Platine supérieure et ensemble support	Set coperchio e supporto
VTR212004	Motor Mount and Adaptor Set	Motorhalter und Adapter Set	Support moteur et ensemble Visserie adaptateur	Set montante e adattatore del motore
VTR212012	Pinion Gear, 16T	Ritzel, 10Z	Pignon, 10 dents	Ruota conica, 10T
VTR215000	Hardware Set	Hardware Set	Visserie	Set bulloni
VTR216002	Body Clips (10)	Karosseriekammern (10)	Clips à carrosserie (10)	Clips carrozzeria (10)

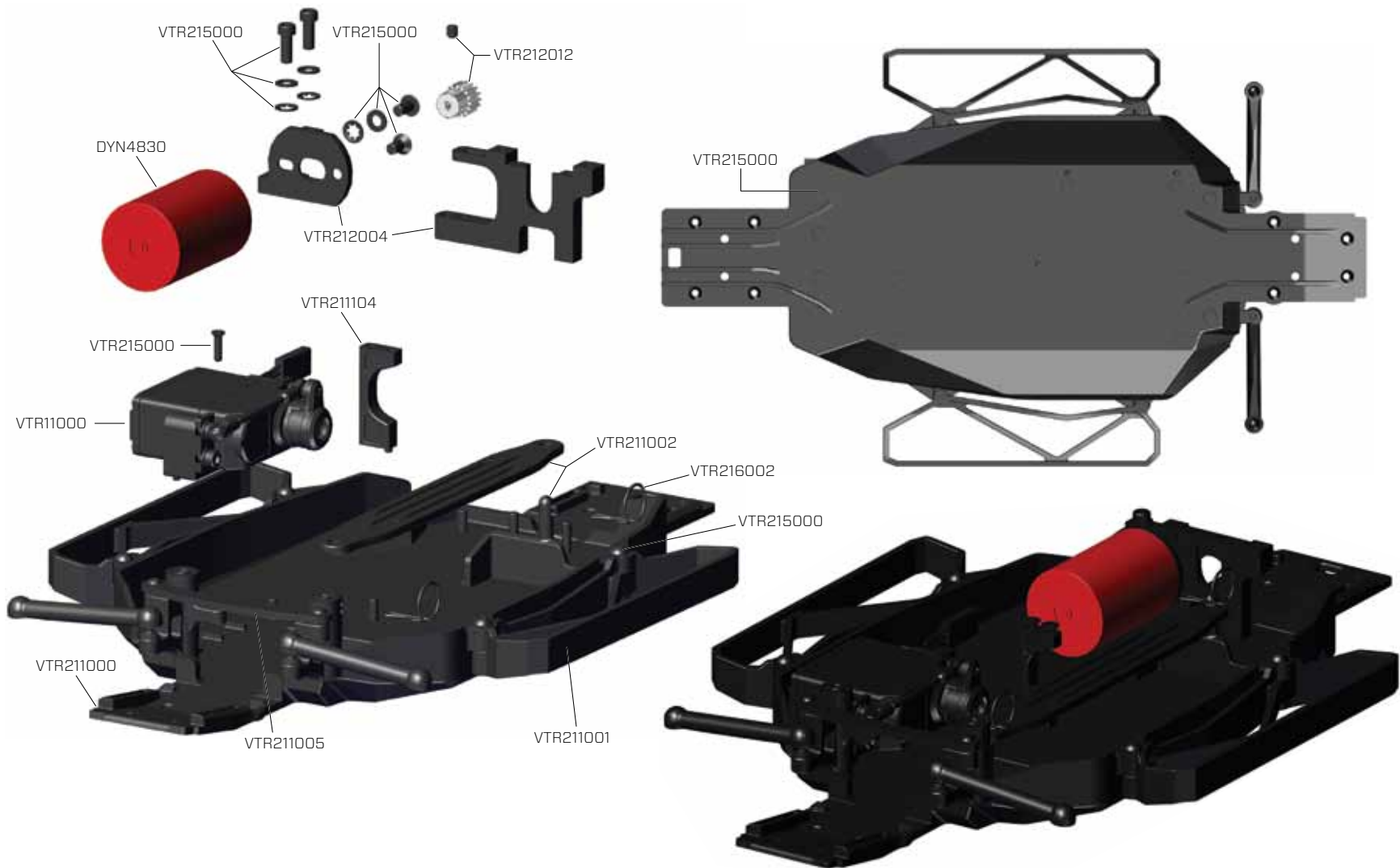

STEERING // LENKUNG // DIRECTION // STERZO //////////////////////////////////////

Part # Nummer Numéro Codice	Description	Beschreibung	Description	Descrizione
VTR11000	903WP Digital Servo	903WP Servo	Servo 903WP	903WP Servo
VTR211005	Steering Hardware Set	Lenkung Hardware Set	Visserie pour direction	Set bulloni sterzo
VTR211103	Servo Saver, Mount and Bell Crank Set	Servosaver / Montage und Ackermann Set	Sauve servo, supports et renvois de direction	Set salvaservo, supporto, squadretta
VTR214006	Steering and Suspension Linkage Set	Anlenkenset für Lenkung/ Aufhängung	Jeu de biellettes de direction et de suspensions	Set collegamenti sterzo e sospensione
VTR215000	Hardware Set	Hardware Set	Visserie	Set bulloni
VTR216000	Ball Stud Set	Kugelkopfset	Jeu de rotules	Set perni sferici
VTR217000	Ball Bearing Set	Kugellager Set	Jeu de roulements	Set cuscinetti a sfere

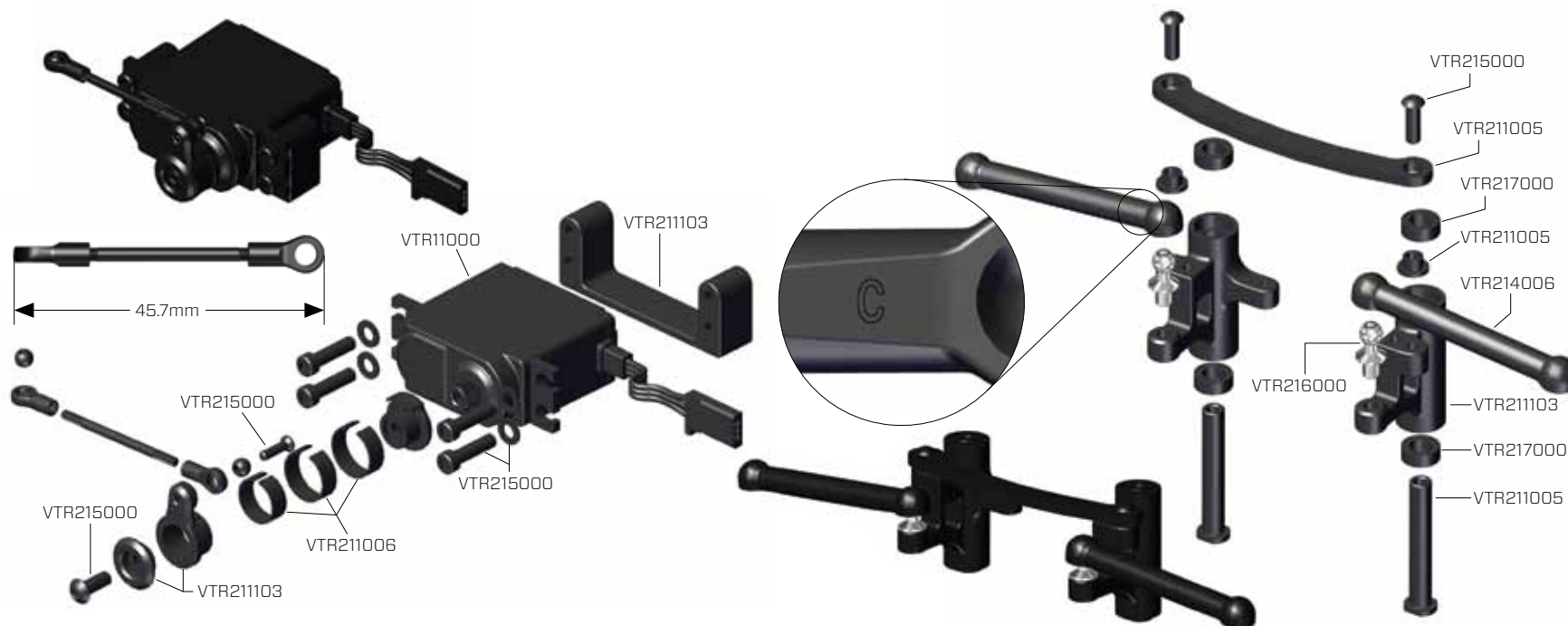

OPTIONAL PARTS // DIVERSE TEILE // PIÈCES OPTIONNELLES // COMPONENTI OPZIONALI //

Part # Nummer Numéro Codice	Description	Beschreibung	Description	Descrizione
DYN1476	7.4V 2000mAh 2S 30C Li-Po, Long, EC3	7.4V 2000mAh 2S 30C Li-Po, Long, EC3	7.4V 2000mAh 2S 30C Li-Po, Long, EC3	7.4V 2000mAh 2S 30C Li-Po, Long, EC3
DYN1477	11.1V 1400mAh 3S 30C Li-Po, Long: EC3	11.1V 1400mAh 3S 30C Li-Po, Long: EC3	11.1V 1400mAh 3S 30C Li-Po, Long: EC3	11.1V 1400mAh 3S 30C Li-Po, Long: EC3
VTR210002	Body Set, Clear	Body Set, Transparent	Carrosserie, Transparente	Kit Carrozzeria, Trasparente
VTR210004	Chassis Cover, Clear	Chassis, Transparent	Châssis, Transparente	Telaio, Trasparente
VTR213009	FR Shock Spring Set, Firm	Federnsatz vorne	Jeu de ressorts d'amortisseur avant	Set molle ammortizz. FR - dure
VTR213010	RR Shock Spring Set, Firm	Federnsatz hinten	Jeu de ressorts d'amortisseur arrière	Set molle ammortizz. RR - dure
VTR213011	FR Shock Spring Set, Soft	Federnsatz vorne	Jeu de ressorts d'amortisseur avant	Set molle ammortizz. FR - morbide
VTR213012	RR Shock Spring Set, Soft	Federnsatz hinten	Jeu de ressorts d'amortisseur arrière	Set molle ammortizz. RR - morbide
VTR311000	Servo Mount, Aluminum	Servohalter Aluminium	Support de servo en aluminium	Supporto servo, alluminio
VTR312000	Rear CV Driveshaft Set (2)	CV Antriebswelle Set (2) hinten	Jeu de cardans CVD arrière (2)	Set trasmissione poster. CV (2)
VTR312001	Front CV Driveshaft Set (2)	CV Antriebswelle Set (2) vorne	Jeu de cardans CVD avant (2)	Set trasmissione anter. CV (2)
VTR312002	F/R CV Driveshaft Axles (2)	CV Achse vorne/hinten	Jeu d'axes de cardan CVD AV/ARR (2)	Assi trasmissione F/R CV (2)
VTR312003	F/R CV Driveshaft Coupling Set (2)	Antriebswelle Kupplung Set (2)	Jeu de liaisons de cardan CVD AV/ ARR (2)	Set giunti trasmissione F/R CV (2)
VTR312004	Rear CV Driveshaft (2)	Antriebswelle CV hinten (2)	Jeu de tiges de cardan CVD arrière (2)	Trasmissione poster. CV (2)
VTR312005	Front CV Driveshaft (2)	Antriebswelle CV vorne (2)	Jeu de tiges de cardan CVD avant (2)	Trasmissione anter. CV (2)
VTR312006	Wheel Hex Set, Aluminum	Radmutternset, Aluminium	Jeu d'hexagones de roues en aluminium	Set esagoni ruote, alluminio
VTR312007	Pinion Gear, 10T	Ritzel, 10Z	Pignon, 10 dents	Ruota conica, 10T
VTR312008	Pinion Gear, 12T	Ritzel, 12Z	Pignon, 12 dents	Ruota conica, 12T
VTR312009	Pinion Gear, 14T	Ritzel, 14Z	Pignon, 14 dents	Ruota conica, 14T
VTR314000	Front Suspension Mount Set, Aluminum	Querlenkerhalterset vorne	Ensemble support de suspensions avant	Set montante sospensione anteriore
VTR314001	Rear Suspension Mount Set, Aluminum	Querlenkerhalterset hinten, Aluminium	Ensemble support de suspensions arrière en aluminium	Set montante sospensione posteriore, alluminio

Part # Nummer Numéro Codice	Description	Beschreibung	Description	Descrizione
VTR314002	Spindle Set, Aluminum	Achsschenkelset Aluminium	Jeu de fusées en aluminium	Set perno, alluminio
VTR314003	Carrier Set, Aluminum	Radträgerset, Aluminium	Jeu d'étriers porte fusées en aluminium	Set supporto, alluminio
VTR314004	Rear Hub Set, Aluminum	Radträger kpl. Aluminium	Jeu de fusées arrières en aluminium	Set mozzo poster., alluminio

FPO

SEE:

36654_KALAHARICOVER_SPREAD.INDD

**FOR FRONT AND
BACK COVERS**