



















# FASTENERS // VERBINDUNGSELEMENTE // VISSERIE // ELEMENTI DI FISSAGGIO //////////////////////////////////////

 <p>x 4 M3 x 18mm Cap Head Screw M3 x 18mm Innensechskantschrauben Vis à tête creuse M3 x 18mm Viti a testa bombata M3 x 18mm</p>	 <p>x 16 M2 x 10mm Cap Head Screw M2 x 10mm Innensechskantschrauben Vis à tête creuse M2 x 10mm Viti a testa bombata M2 x 10mm</p>	 <p>x 4 M3 x 10mm Philips Screw M3 x 10 Phillipsschraube Vis cruciforme à tête fraisée M3 x 10mm M3 x 10mm Vite con testa a croce</p>	 <p>x 4 M2 x 8mm Flat Head Screw M2 x 8mm Flachkopfschrauben Vis à tête fraisée M2 x 8mm Viti a testa piatta M2 x 8mm</p>	 <p>x 5 M3 Nylock Nut M3 Mutter Nylock Ecrou Nylock M3 Dado Nylock M3</p>
 <p>x 4 M2 x 23mm Cap Head Screw M2 x 23mm Innensechskantschrauben Vis à tête creuse M2 x 23mm Viti a testa bombata M2 x 23mm</p>	 <p>x 28 M2 x 6mm Cap Head Screw M2 x 6mm Innensechskantschrauben Vis à tête creuse M2 x 6mm Viti a testa bombata M2 x 6mm</p>	 <p>x 2 M2.6 x 5mm Philips Screw M2.6 x 5 Phillipsschraube Vis cruciforme à tête fraisée M2,6 x 5mm M2.6 x 5mm Vite con testa a croce</p>	 <p>x 6 M2 x 12mm Flat Head Screw M2 x 12mm Flachkopfschrauben Vis à tête fraisée M2 x 12mm Viti a testa piatta M2 x 12mm</p>	 <p>x 4 M4 Nylock Flanged Nut M4 Mutter Nylock angeflanscht Ecrou Nylock bride M4 Dado Nylock flangiato M4</p>
 <p>x 3 M2 x 18mm Cap Head Screw M2 x 18mm Innensechskantschrauben Vis à tête creuse M2 x 18mm Viti a testa bombata M2 x 18mm</p>	 <p>x 4 M2 x 6mm Cap Head Screw M2 x 6mm Innensechskantschrauben Vis à tête creuse M2 x 6mm Viti a testa bombata M2 x 6mm</p>	 <p>x 11 M1.4 x 5mm Philips Screw M1,4 x5mm Phillipsschraube Vis cruciforme à tête fraisée M1,4 x 5mm M1.4 x 5mm Vite con testa a croce</p>	 <p>x 6 M2 x 6mm Flat Head Screw M2 x 6mm Flachkopfschrauben Vis à tête fraisée M2 x 6mm Viti a testa piatta M2 x 6mm</p>	
 <p>x 11 M2 x 14mm Cap Head Screw M2 x 14mm Innensechskantschrauben Vis à tête creuse M2 x 14mm Viti a testa bombata M2 x 14mm</p>	 <p>x 9 M2 x 4mm Cap Head Screw M2 x 4mm Innensechskantschrauben Vis à tête creuse M2 x 4mm Viti a testa bombata M2 x 4mm</p>	 <p>x 8 M1.4 x 4mm Philips Screw M1,4 x4mm Phillipsschraube Vis cruciforme à tête fraisée M1,4 x 4mm M1.4 x 4mm Vite con testa a croce</p>		
 <p>x 12 M2 x 12mm Cap Head Screw M2 x 12mm Innensechskantschrauben Vis à tête creuse M2 x 12mm Viti a testa bombata M2 x 12mm</p>				

# REPLACEMENT PARTS // ERSATZTEILE // PIÈCES DE RECHANGE // PEZZI DI RICAMBIO //

Part #   Nummer Numéro   Codice	Description	Beschreibung	Description	Descrizione
DYNB0105EC	7.2V 1100mAh 6C Ni-MH Battery	Dynamite 7.2V 1100mAh 6C Ni-MH Akkut	Batterie Ni-Mh Dynamite 7.2V 1100mA	Batteria Dynamite 7.2V 1100mAh 6C Ni-MH
DYN4113	2A Ni-MH AC Charger	Dynamite 2A NiMH AC Peak Ladegerät - EU	Chargeur AC rapide 2A	Caricatore 2A Ni-MH AC
DYN4820WP	Tazer Mini Brushed ESC, Waterproof	Dynamite Tazer Mini Bürstenregler spritzwassergeschützt	Variateur Tazer Mini, étanche pour moteur à balais	Regolatore Tazer Mini per motore a spazzole, impermeabile
DYNS1205	1/18 Mini-Rock Crawler Motor	Dynamite 1/18 Mini-Rock Crawler Motor	Moteur pour Mini Rock Crawler 1/18	Motore 1/18 Mini-Rock Crawler
SPMS602	S602 Digital Servo	S602 Digital Servo	Servo digital S602	Servo digitale S602
SPMR2320	DX2E DSM 2-Channel Surface Radio	SPMR2400 DX2E DSM 2-Kanal Surface Fernsteuerung	Radio 2 voies DX2E DSM, surface	SPMR2400 DX2E DSM radio 2 canali
SPMSR200WP	SR200WP 2-Channel DSM Waterproof Sport Receiver	Spektrum SR200WP 2-Kanal DSM spritzwassergeschützter Sport Empfänger	Récepteur 2 voies étanche SR200WP DSM Spektrum	Spektrum SR200WP ricevitore impermeabile 2-canali DSM
VTR215001	Hardware Set Cage: SLK	Überrollkäfig: SLK	Visserie de l'arceau cage: SLK	Set viteria gabbia: SLK
VTR215002	Hardware Set Differential: SLK	Zylinderkopfschraube M2 x 14mm (10): SLK	Set de visserie de transmission centrale: SLK	Set viteria differenziale: SLK
VTR215003	Hardware Set Axle Housing: SLK	Zylinderkopfschraube M2x18mm (10): SLK	Set de visserie pour pont: SLK	Set viteria sede asse: SLK



**DRIVESHAFT // WELLEN // CARDAN // TRASMISSIONE** //////////////////////////////////////

Part #   Nummer Numéro   Codice	Description	Beschreibung	Description	Descrizione
VTR212023	Universal Joints/Slider Shafts, Assembled (2): SLK	Kardangelenke / Teleskopan- triebswelle montiert (2): SLK	Cardans universels télescopiques as- semblés (2): SLK	Giunti universali/alberi scorrevoli assemblati (2): SLK

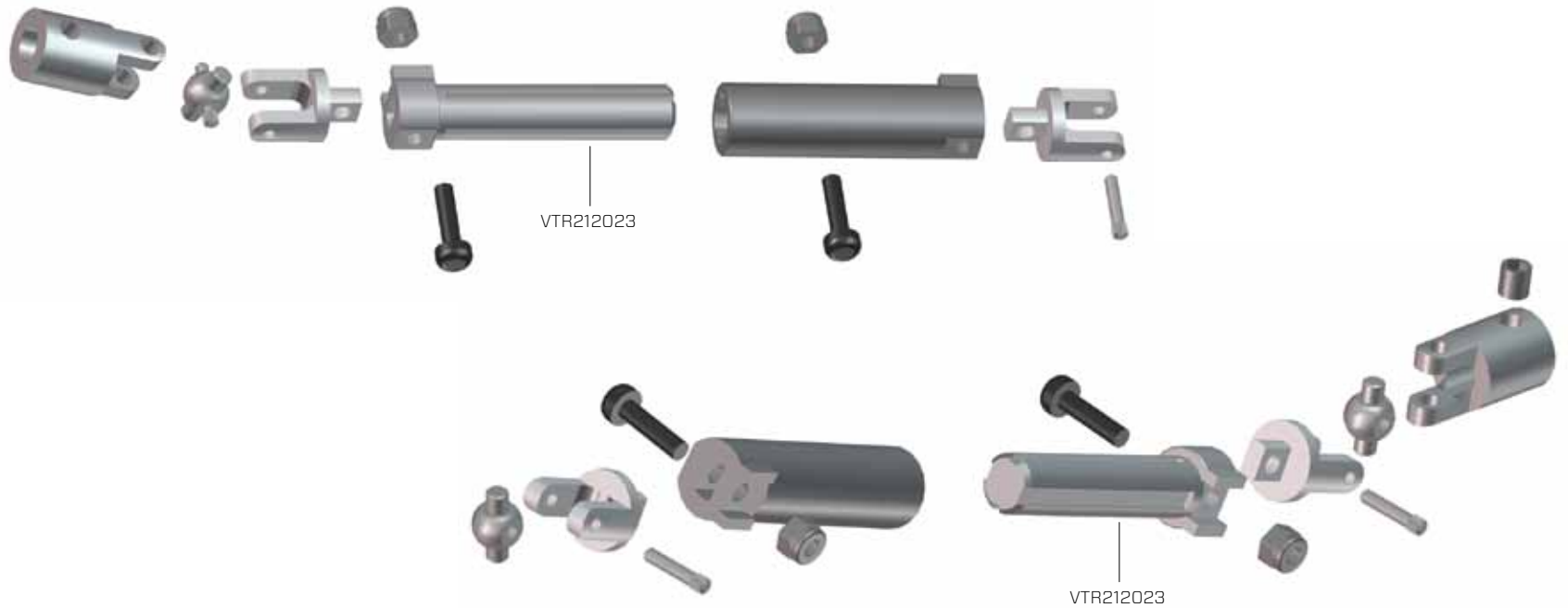

## BATTERY BOX // AKKUBOX // COMPARTIMENT À BATTERIE // SCATOLA BATTERIA //////////////////////////////////////

Part #   Nummer Numéro   Codice	Description	Beschreibung	Description	Descrizione
VTR211016	Battery Box: SLK	Akkubox: SLK	Compartment à batterie: SLK	Scatola batteria: SLK

## SERVO SAVER // SERVOSAVER // SAUVE SERVO // SALVA SERVO //////////////////////////////////////

Part #   Nummer Numéro   Codice	Description	Beschreibung	Description	Descrizione
VTR211018	Servo Saver Set: SLK	Servosaver: SLK	Sauve servo: SLK	Set salva servo: SLK
SPMS602	S602 Digital Servo	S602 Digital Servo	Servo digital S602	Servo digitale S602

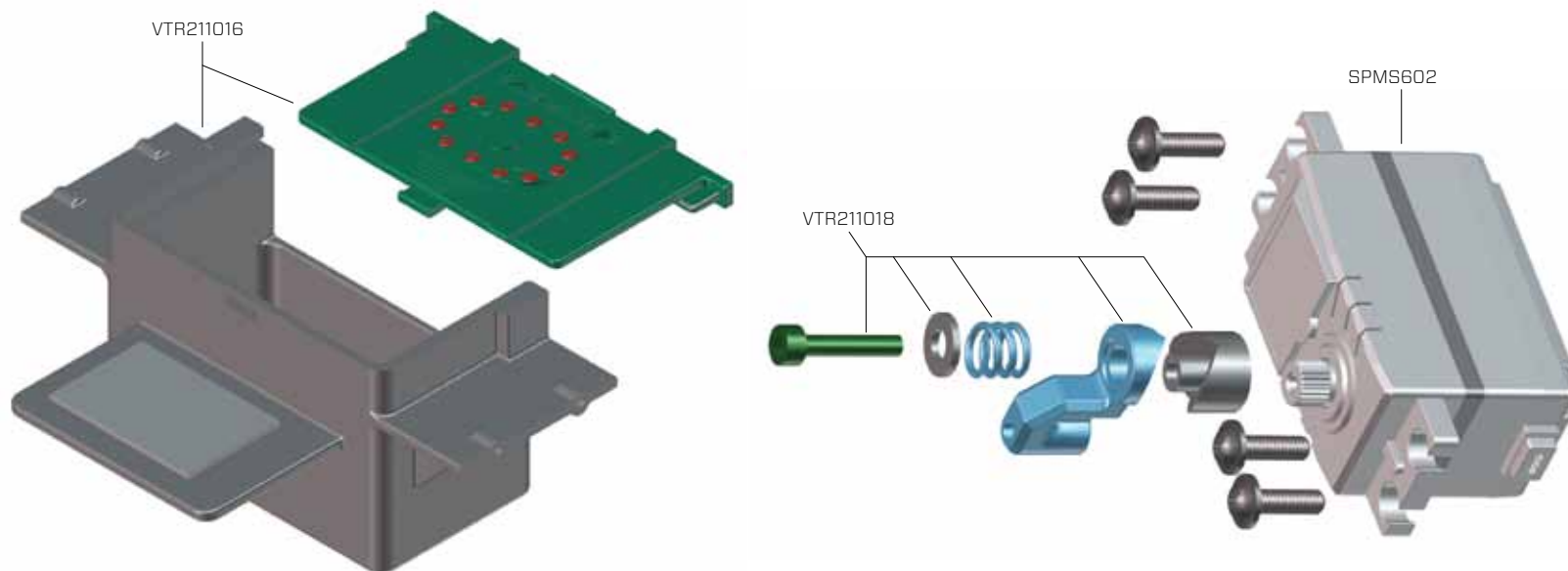

# FRONT SUSPENSION // FRONT AUFHÄNGUNG // SUSPENSION AVANT // SOSPENSIONE ANTERIORE //////////////////////////////////////

Part #   Nummer Numéro   Codice	Description	Beschreibung	Description	Descrizione
VTR211015	Transmission Skid Plate: SLK	Antriebsschutz: SLK	Plaque de protection: SLK	Piastra pattino trasmissione: SLK
VTR214012	3 Link Connector Set: SLK	3 Wege Verbinderset: SLK	Set de biellette à 3 points: SLK	Set connettore 3 link: SLK
VTR214015	Lower Suspension Link Set (4): SLK	Unteres Fahrwerksset (4): SLK	Set de tirants inférieurs (4): SLK	Set collegamento inferiore sospensione (4): SLK

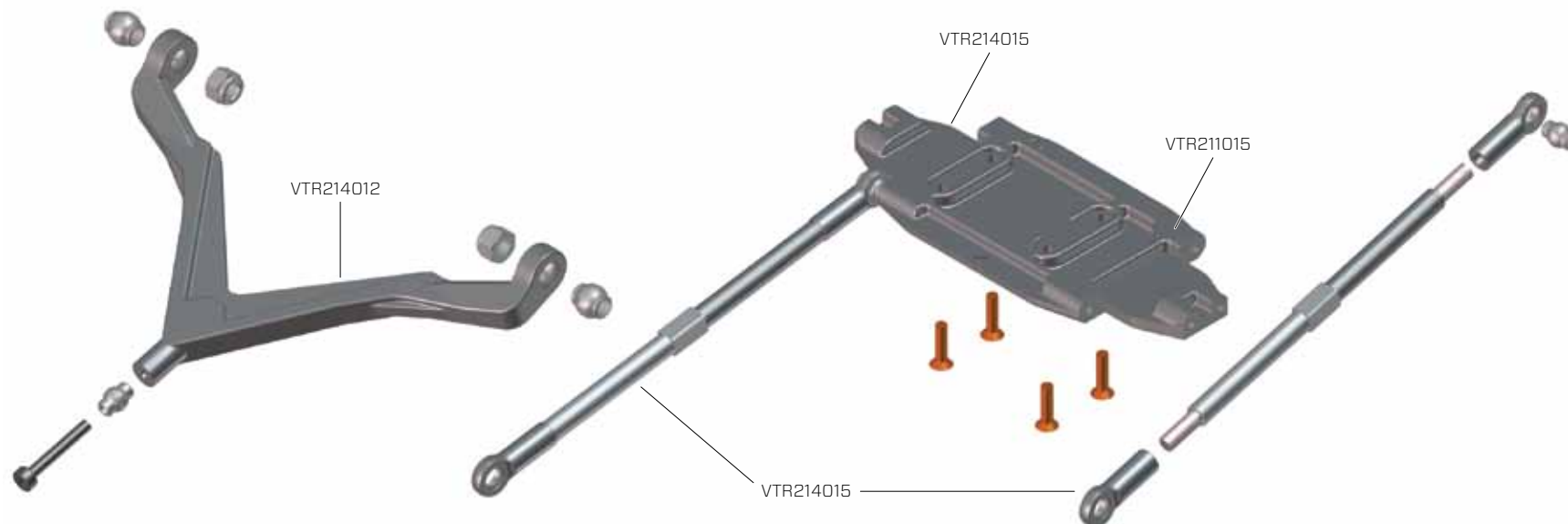

# REAR SUSPENSION // HECK AUFHÄNGUNG // SUSPENSION ARRIÈRE // SOSPENSIONE POSTERIORE //////////////////////////////////////

Part #   Nummer Numéro   Codice	Description	Beschreibung	Description	Descrizione
VTR214015	Lower Suspension Link Set (4): SLK	Unteres Fahrwerksset (4): SLK	Set de tirants inférieurs (4): SLK	Set collegamento inferiore sospensione (4): SLK
VTR214012	3 Link Connector Set: SLK	3 Wege Verbinderset: SLK	Set de biellette à 3 points: SLK	Set connettore 3 link: SLK

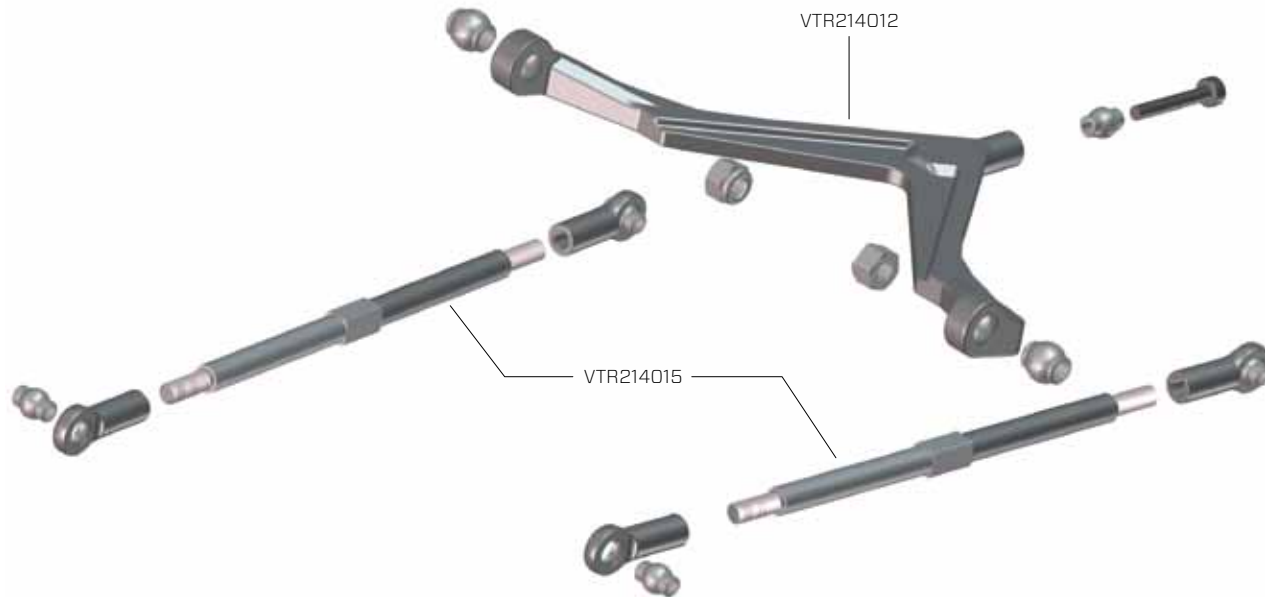

## REAR AXLE // HINTEN ACHSEN // AXES ARRIÈRE // ASSE POSTERIORE //////////////////////////////////////

Part #   Nummer Numéro   Codice	Description	Beschreibung	Description	Descrizione
VTR211017	Servo Plate & Mount Set: SLK	Servoplatte und Montageset: SLK	Platine et support de servo: SLK	Set piastra servo e supporto: SLK
VTR212014	12mm Wheel Hex Set: SLK	12mm Radmitnehmerset: SLK	Set d'hexagones de roues 12mm: SLK	Set esagoni ruota 12mm: SLK
VTR212015	Axle Housings with Hardware(2): SLK	Achsgehäuse mit Zubehör (2) SLK	Carters de pont avec visserie (2): SLK	Sede albero con viteria (2): SLK
VTR212016	Axle Shafts (2): SLK	Buggy Radachse (2): SLK	Arbres de transmission (2): SLK	Alberi asse (2): SLK
VTR214013	Rear Hub Set with Hardware (2): SLK	Radträgerset mit Zubehör (2): SLK	Fusées arrière avec visserie (2): SLK	Set mozzo posteriore con viteria (2): SLK
VTR215003	Hardware Set Axle Housing: SLK	Zylinderkopfschraube M2x18mm (10): SLK	Set de visserie pour pont: SLK	Set viteria sede asse: SLK





# TRANSMISSION // GETRIEBE // TRANSMISSION // TRANSMISSIONE //////////////////////////////////////

Part #   Nummer Numéro   Codice	Description	Beschreibung	Description	Descrizione
DYNS1205	1/18 Mini-Rock Crawler Motor	1/18 Mini-Rock Crawler Motor	Moteur pour Mini Rock Crawler 1/18	Motore 1/18 Mini-Rock Crawler
VTR212017	Output Shaft Set, Axles & Center Diff (2): SLK	Antriebsklauen / Wellen und Mittel Diff (2): SLK	Axes de sortie de diff central (2): SLK	Set uscita albero, assi e differenziale centrale (2): SLK
VTR212019	Top Shaft & Idler Shaft: SLK	Slipperwelle und Idler Gear Stift: SLK	Axe supérieur et axe intermédiaire: SLK	Albero superiore e albero tenditore: SLK
VTR212020	Center Transmission Gear Set: SLK	Getriebeset mittlerer Antriebsstrang: SLK	Set de pignons de transmission centrale: SLK	Set ingranaggi trasmissione centrale: SLK
VTR212021	Center Diff Locker: SLK	Sperrdiff mitte: SLK	Verrou de diff central: SLK	Bloccaggio differenziale centrale: SLK
VTR212022	Slipper Hardware Set: SLK	Slipper Set: SLK	Set d'accessoires de slipper: SLK	Set viteria slipper: SLK
VTR212024	Center Transmission Case Set: SLK	Antriebsgehäuseset Mitte: SLK	Carter de transmission centrale: SLK	Set carter trasmissione centrale: SLK
VTR212025	Motor Plate: SLK	Buggy Motorplatte: SLK	Support moteur: SLK	Piastra motore: SLK
VTR212026	Outdrive: SLK	Antriebsklaue: SLK	Noix de cardan: SLK	Bicchierino: SLK
VTR215002	Hardware Set Differential: SLK	Zylinderkopfschraube M2 x 14mm (10): SLK	Set de visserie de transmission centrale: SLK	Set viteria differenziale: SLK

Hardware set VTR215002  
Hardware set  
Visserie  
Set bulloni

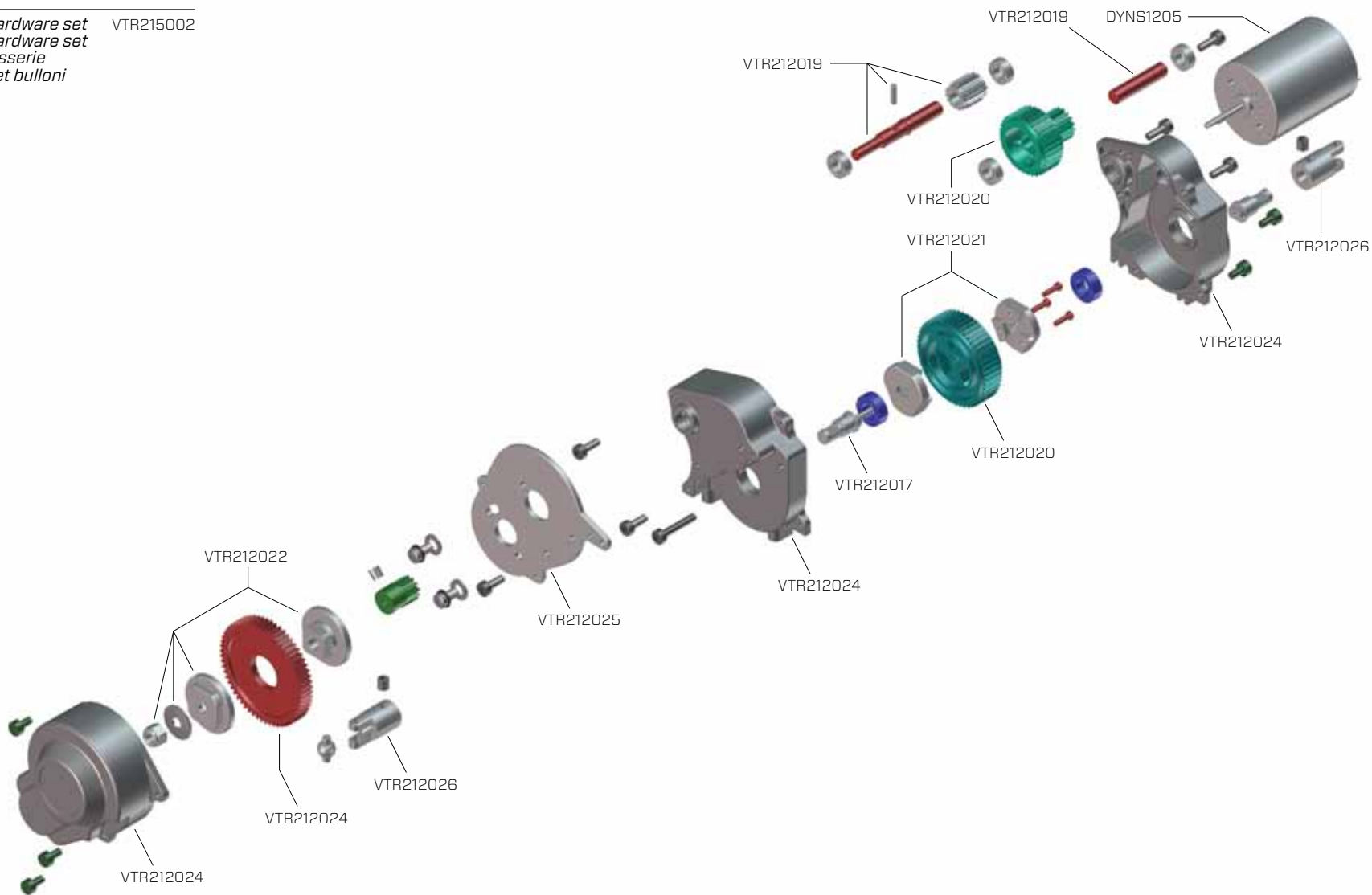

**ROLLBAR ASSEMBLY // ÜBERROLLBÜGEL // ASSEMBLAGE DE L'ARCEAU // GRUPPO ROLLBAR //////////////////////////////////////**

Part #   Nummer Numéro   Codice	Description	Beschreibung	Description	Descrizione
VTR210012	Roll Cage Set: SLK	Buggy Überrollkäfig: SLK	Arceau Cage: SLK	Set gabbia protezione: SLK
VTR210013	Body Panel Set: SLK	Karosserieverkleidung: SLK	Set de panneaux de carrosserie: SLK	Set pannello carrozzeria: SLK
VTR210014	Light Bar Housing: SLK	Scheinwerfergehäuse SLK	Boîtier de rampe lumineuse: SLK	Sede barra luci: SLK
VTR215001	Hardware Set Cage: SLK	Überrollkäfig: SLK	Visserie de l'arceau cage: SLK	Set viteria gabbia: SLK

Hardware set VTR215001  
Hardware set  
Visserie  
Set bulloni

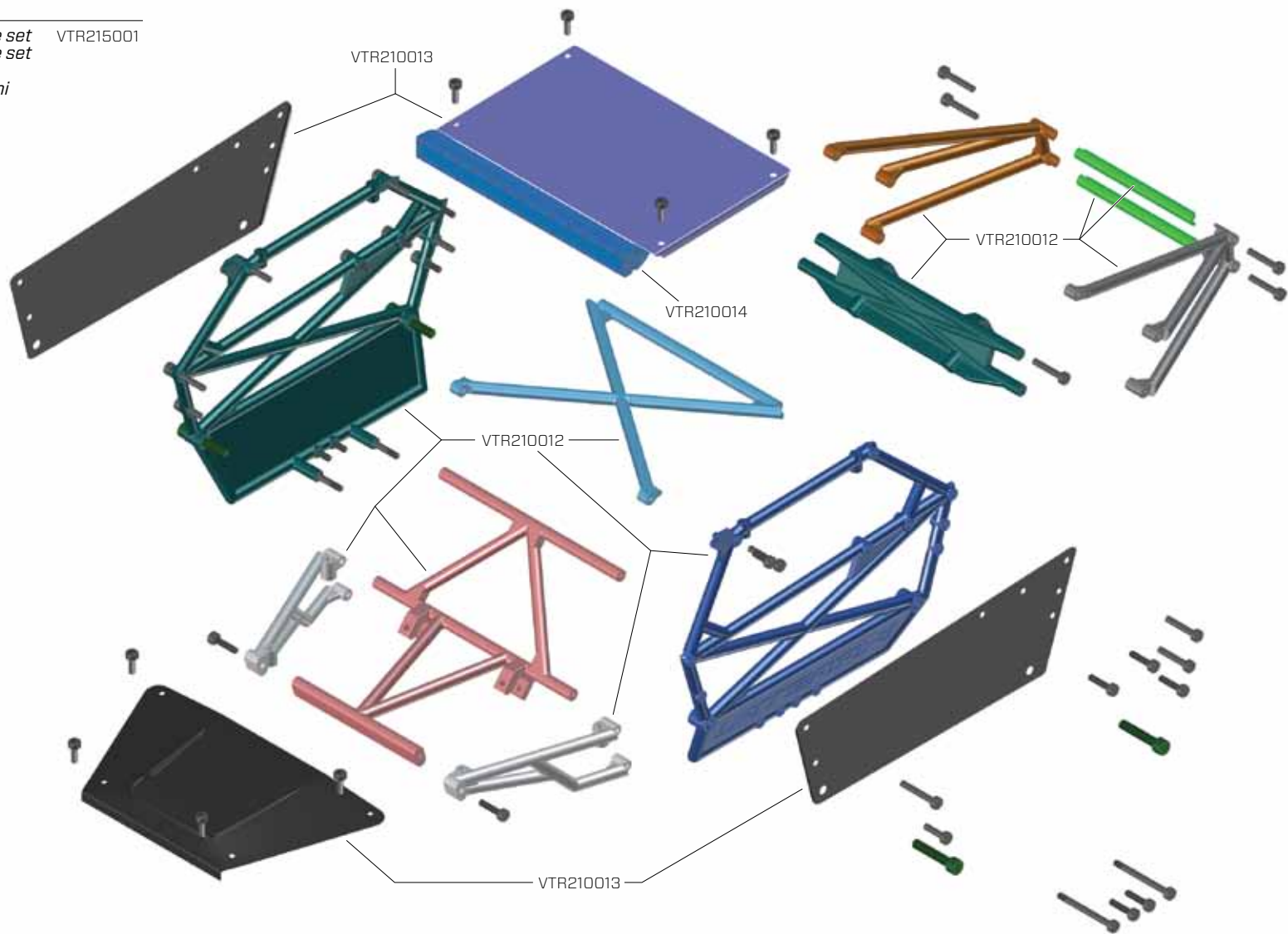



# STEERING // LENKUNG // DIRECTION // STERZO //////////////////////////////////////

Part #   Nummer Numéro   Codice	Description	Beschreibung	Description	Descrizione
VTR211018	Servo Saver Set: SLK	Servosaver: SLK	Sauve servo: SLK	Set salva servo: SLK
VTR212014	12mm Wheel Hex Set: SLK	12mm Radmitnehmerset: SLK	Set d'hexagones de roues 12mm: SLK	Set esagoni ruota 12mm: SLK
VTR214014	Steering Links, Long & Short: SLK	Lenkgestänge Kurz u. Lang: SLK	Biellettes de direction, courte et longue: SLK	Rinvii sterzo lunghi e corti: SLK
VTR214016	Front Spindles & Carriers with Hardware: SLK	Lenkhebel und Trägerset mit Zubehör: SLK	Fusées et étriers porte-fusées av avec visserie: SLK	Supporti semiassi anter. con viteria: SLK
VTR217001	Ball Bearing Set: SLK	Buggy Kugellagerset: SLK	Set de roulements: SLK	Set cuscinetti a sfere: SLK

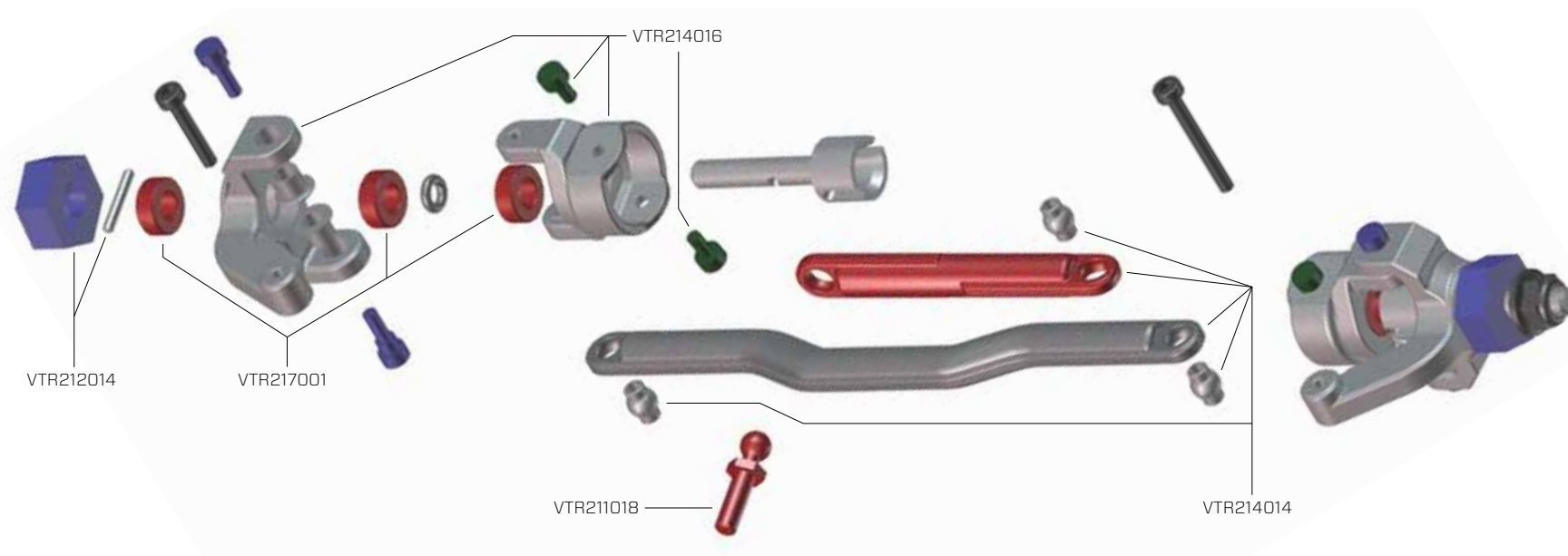

# OPTIONAL PARTS // DIVERSE TEILE // PIÈCES OPTIONNELLES // COMPONENTI OPZIONALI // // // // // // // //

Part #   Nummer Numéro   Codice	Description	Beschreibung	Description	Descrizione
VTR212027	Front/Rear Metal Differential Locker (1): SLK	Sperdiff. v/h (1): SLK	Verrou de différentiel en métal AV/arr (1): SLK	Blocco differenziale metallico anter/poster (1): SLK
VTR212028	Center Metal Diff Locker (1): SLK	Mitteldiff. (1): SLK	Verrou de différentiel central en métal (1): SLK	Blocco diff. centrale metallo (1): SLK
VTR310000	LED Light Bar Kit: SLK	LED Lichtleiste Kit: SLK	Rampe lumineuse à DELs: SLK	Kit barra luminosa a LED: SLK
VTR312010	12mm Wheels Hex Set, Aluminum: SLK	12mm Radmutterset: SLK	Set d'hexagones de roues en aluminium 12mm: SLK	Set esagoni ruote 12mm, alluminio: SLK
VTR312011	Front Carrier Set: SLK	Radträger set vorne: SLK	Porte-fusées avant en aluminium: SLK	Set supporto anteriore: SLK
VTR313000	Rebuild Kit Aluminum Shock Set: SLK	Alu Stoßdämpferreparaturset: SLK	Kit de réparation pour amortisseur en aluminium: SLK	Kit ricostruzione set ammortizzatori alluminio: SLK
VTR313001	Threaded Shock Set, Aluminum w/ Ti-Ni Shaft: SLK	Stoßdämpfer set geh. Alu m. Ti-Ni Kolben: SLK	Set d'amortisseurs filetés en aluminium avec tiges Ti-Ni: SLK	Set ammort. filettato, alluminio c/albero Ti-Ni: SLK
VTR314005	Lower 30 Deg High-Clearance Suspension Links Alum: SLK	30° High Clearance Querlenker Alu: SLK	Tirants inférieurs en aluminium Coudés 30°: SLK	Rinvii sospensione inferiore 30° distanza elevata, alluminio: SLK











---

VATERRA®

---

It is a shared passion for motorsports and radio control. Extreme performance and extreme places. Cars and trucks that look and drive just like the real thing. Most of all, it is about gathering friends, grabbing a vehicle and having the time of your life.

---

**Adventure Driven.™**