

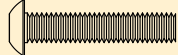





















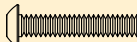
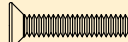

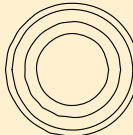
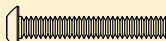

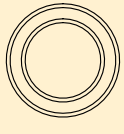

FASTENERS // VERBINDUNGSELEMENTE // ÉLÉMENTS DE FIXATION // ELEMENTI DI FISSAGGIO //////////////////////////////////////

 VTR235095 X 10 M2.5 x 4mm Button Head Screw M2,5 x 4mm Halbrundsrauben Vis à tête bombée M2,5 x 4mm Viti testa tonda M2,5 x 4mm	 VTR235125 X 10 M4 x 20mm Button Head Screw M4 x 20mm Halbrundsrauben Vis à tête bombée M4 x 20mm Viti testa tonda M4 x 20mm	 VTR235320 X 10 M3 x 3mm Ringschneide Gewindestift M3 x 3mm Ringschneide Gewindestift Vis Imbus à bout cuvette M3 x 3mm Tazza punto grani M3 x 3mm	 VTR236104 X 10 2.5mm x 4.6mm x .5mm Washer 2,5mm x 4,6mm x ,5mm Unterlegscheiben Rondelle 2,5mm x 4,6mm x ,5mm Rondella 2,5mm x 4,6mm x ,5mm	 VTR237014 X 2 6mm x 12mm x 4mm Ball Bearing 6mm x 12mm x 4mm Kugellager Roulement 6mm x 12mm x 4mm Cuscinetto a sfere 6mm x 12mm x 4mm		
 VTR235098 X 10 M2.5 x 8mm Button Head Screw M2,5 x 8mm Halbrundsrauben Vis à tête bombée M2,5 x 8mm Viti testa tonda M2,5 x 8mm	 VTR235174 X 10 M3 x 6mm Flat Head Screw M3 x 6mm Flachkopfschrauben Vis à tête fraisée M3 x 6mm Viti a testa piatta M3 x 6mm	 VTR235343 X 10 M4 x 4mm Cup Point Set Screw M4 x 4mm Ringschneide Gewindestift Vis Imbus à bout cuvette M4 x 4mm Tazza punto grani M4 x 4mm	 VTR236076 X 10 3.2mm x 7mm x .5mm Washer 3,2mm x 7mm x ,5mm Unterlegscheiben Rondelle 3,2mm x 7mm x ,5mm Rondella 3,2mm x 7mm x ,5mm	 VTR237019 X 2 8mm x 12mm x 3.5mm Ball Bearing 8mm x 12mm x 3.5mm Kugellager Roulement 8mm x 12mm x 3.5mm Cuscinetto a sfere 8mm x 12mm x 3.5mm		
 VTR235107 X 10 M3 x 10mm Button Head Screw M3 x 10mm Halbrundsrauben Vis à tête fraisée M3 x 10mm Viti testa tonda M3 x 10mm	 VTR235176 X 10 M3 x 10mm Flat Head Screw M3 x 10mm Flachkopfschrauben Vis à tête fraisée M3 x 10mm Viti a testa piatta M3 x 10mm	 VTR236013 X 10 M2.5 Nylock Nut M2,5 Mutter Nylock Ecrou Nylock M2,5 Dado Nylock M2,5	 VTR237003 X 2 4mm x 8mm x 3mm Ball Bearing 4mm x 8mm x 3mm Kugellager Roulement 4mm x 8mm x 3mm Cuscinetto a sfere 4mm x 8mm x 3mm	 VTR237009 X 2 5mm x 13mm x 4mm Ball Bearing 5mm x 13mm x 4mm Kugellager Roulement 5mm x 13mm x 4mm Cuscinetto a sfere 5mm x 13mm x 4mm		
 VTR235110 X 10 M3 x 16mm Button Head Screw M3 x 16mm Halbrundsrauben Vis à tête bombée M3 x 16mm Viti testa tonda M3 x 16mm	 VTR235179 X 10 M3 x 16mm Flat Head Screw M3 x 16mm Flachkopfschrauben Vis à tête fraisée M3 x 16mm Viti a testa piatta M3 x 16mm	 VTR236014 X 10 M3 Nylock Nut M3 Mutter Nylock Ecrou Nylock M3 Dado Nylock M3	 VTR237004 X 2 5mm x 10mm x 4mm Ball Bearing 5mm x 10mm x 4mm Kugellager Roulement 5mm x 10mm x 4mm Cuscinetto a sfere 5mm x 10mm x 4mm	 VTR237029 X 2 12mm x 18mm x 4mm Ball Bearing 12mm x 18mm x 4mm Kugellager Roulement 12mm x 18mm x 4mm Cuscinetto a sfere 12mm x 18mm x 4mm		
 VTR235112 X 10 M3 x 20mm Button Head Screw M3 x 20mm Halbrundsrauben Vis à tête bombée M3 x 20mm Viti testa tonda M3 x 20mm	 VTR235013 X 10 M2.5 x 8mm Cap Head Screw M2,5 x 8mm Innensechskantschrauben Vis à tête creuse M2,5 x 8mm Viti a testa bombata M2,5 x 8mm	 VTR236015 X 10 M4 Nylock Nut M4 Mutter Nylock Ecrou Nylock M4 Dado Nylock M4	 VTR237013 X 2 6mm x 10mm x 3mm Ball Bearing 6mm x 10mm x 3mm Kugellager Roulement 6mm x 10mm x 3mm Cuscinetto a sfere 6mm x 10mm x 3mm	 VTR237028 X 2 10mm x 15mm x 4mm Nylon Retainer Ball Bearing Nylonkugellager gekapstelt 10 x 15 x 4mm Roulement 10mm x 15mm x 4mm à cage nylon Cuscinetto a sfere con fermo in nylon 10mm x 15mm x 4mm		
 VTR235122 X 10 M4 x 10mm Button Head Screw M4 x 10mm Halbrundsrauben Vis à tête bombée M4 x 10mm Viti testa tonda M4 x 10mm	 VTR235023 X 10 M3 x 6mm Cap Head Screw M3 x 6mm Innensechskantschrauben Vis à tête creuse M3 x 6mm Viti a testa bombata M3 x 6mm	 VTR236016 X 10 M5 Nylock Nut M5 Mutter Nylock Ecrou Nylock M5 Dado Nylock M5	 VTR236044 X 10 M5 Nylock Flanged Serrated Nut M5 Mutter Nylock angeflanscht gezackt Ecrou Nylock bride en dents de scie M5 Dado Nylock flangiato seghettato M5	 VTR235227 X 10 U-Joint Screw: Hal U-Verbinder Schraube: Hal Vis de liaison: Hal Vite con giunto a U: Hal	 VTR236137 X 10 E-Clip, 5mm E-Clip, 5mm E-Clip, 5mm E-Clip, 5mm	 VTR236138 X 10 C-Clip, 6mm C-Clip, 6mm C-Clip, 6mm C-Clip, 6mm

REPLACEMENT PARTS // ERSATZTEILE // PIÈCES DE RECHANGE // PEZZI DI RICAMBIO //

Part # Nummer Numéro Codice	Description	Beschreibung	Description	Descrizione
DYN4833	Dynamite Fuze 540 4-Pole 3300Kv Sensorless Brushless Motor	DYN4833T Dynamite Fuze 540 4-Pole 3300Kv Sensorloser Brushless Motor	Moteur brushless sensorless Dyna- mite Fuze 540 4-pôles 3300kV	DYN4833T Dynamite Fuze 540 4-Poli 3300Kv Motore Sensorless Brushless
DYN4850	Dynamite Fuze 70A Waterproof Sensorless Brushless ESC	DYN4850T Dynamite Fuze 70A spritzwasserdichter Sensorloser Brushless Regler	Contrôleur brushless sensorless étanche Dynamite Fuze 70A	DYN4850T Dynamite Fuze 70A ESC impermeabile Sensorless Brushless
SPMR2320	DX2E DSM 2-Channel Surface Radio	SPMR2400 DX2E DSM 2-Kanal Surface Fernsteuerung	Radio 2 voies DX2E DSM, surface	SPMR2400 DX2E DSM radio 2 canali
SPMSRS4200	SRS4200 4-Channel DSMR AVC Receiver, Waterproof	SRS4200 4-Kanal DSMRAVC Empfänger, Spritzwassergeschützt	Récepteur SRS4200 4 voies DSMR AVC étanche	Ricevitore SRS4200 4-canali DSMR AVC, impermeabile
SPMSS6170	Standard Digital Surface Servo, Waterproof	Standard Digital Surface Servo, Spritzwassergeschützt	Servo standard digital étanche pour voiture	Servo car standard digitale, impermeabile
VTR243005	Shock, Rod End Tool: GLU	Stoßdämpfereinstellwerkzeug: GLU	Outil à amortisseur et biellette: GLU	Ammortizzatore, attrezzo terminale asta: GLU

SHOCK ASSEMBLY // STOSSDÄMPFER // ASSEMBLAGE DES AMORTISSEURS // GRUPPO AMMORTIZZATORI //

Part # Nummer Numéro Codice	Description	Beschreibung	Description	Descrizione
VTR233016	Shock Body & Guard, Fr/Rr: Hal	Stoßdämpfergehäuse v/h: Hal	Corps d'amortisseur Av/arr et protection: Hal	Corpo e protezione ammortizzatore, anter/ poster: Hal
VTR233017	Shock Shaft, 3mm x 58.2mm (2): Hal	Stoßdämpferkolben 3mm x 58,2 (2) Hal	Tige d'amortisseur 3mmx58.2mm (2): Hal	Albero ammortizzatore, 3mm x 58.2mm (2): Hal
VTR233018	Springs, Fr/Rr: Hal	Federn, v/h: Hal	Ressorts Av/arr: Hal	Molle anter/poster: Hal
VTR243002	Shock Plastics: GLU	Dämpfer Kunststoff: GLU	Pièces plastiques d'amortisseurs: GLU	Parti in plastica ammortizzatori: GLU
VTR243003	Shock Pistons: GLU	Kolbenplatten: GLU	Pistons d'amortisseurs: GLU	Pistoni ammortizzatori: GLU
VTR243004	Shock Bottom Cap, Plastic: GLU	Dämpferkappen Oben / Kunststoff: GLU	Bouchon inférieur d'amortisseur: GLU	Tappo infer. ammortizzatore in plastica: GLU
VTR243006	Shock Cap (2): GLU	Dämpferkappen (2): GLU	Bouchon d'amortisseur (2): GLU	Tappo ammortizz. (2): GLU
VTR243008	O-Ring, Shocks (8): GLU	O-Ring / Dämpfer (8): GLU	Joints toriques d'amortisseurs (8): GLU	O-ring, ammortizz. (8): GLU
VTR243009	O-Ring, Top Cap (4): GLU	O-Ring / Dämpferkappe (4): GLU	Joints toriques de bouchons d'amortisseurs (4): GLU	O-ring, tappo super. (4): GLU
VTR243010	O-Ring, Bleeder Screw (4): GLU	O-Ring / Entlüftungsschraube (4): GLU	Joint torique de vis de purge d'amortisseurs (4): GLU	O-ring, vite spurgo (4): GLU
VTR246005	Flanged Pivot Ball, 5.8 x 3 x 7mm (10): GLU	Kugelkopf mit Flansch 5.8mm x 3mm x 7mm (10): GLU	Rotules épaulées 5,8 x 3 x 7mm (10): GLU	Perno sfera flangiata 5,8 x 3mm x 7mm (10): GLU

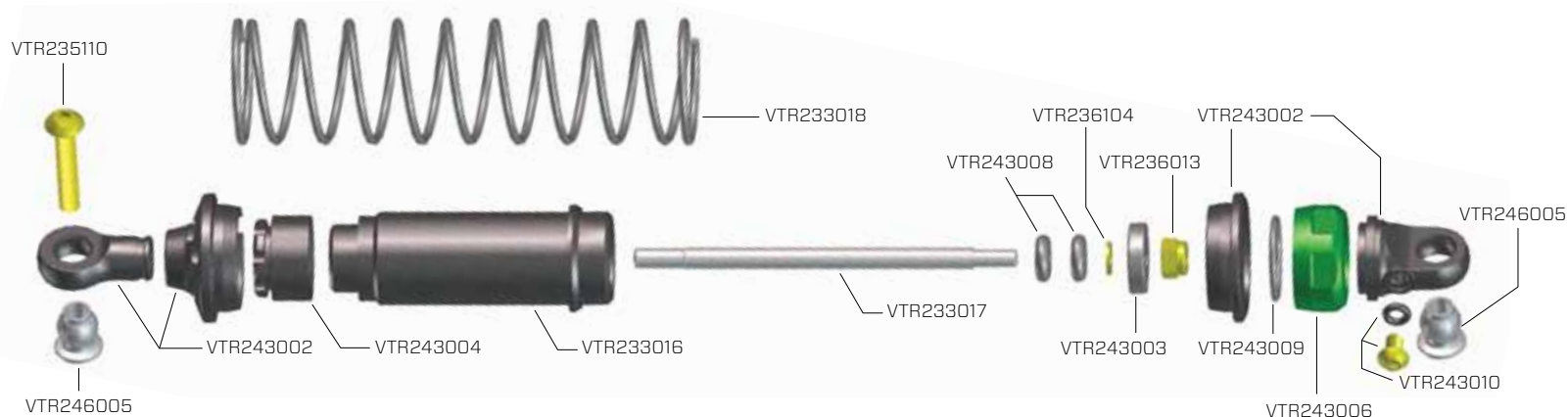

SHOCK TOWERS // STOSSDÄMPFERBRÜCKE // SUPPORTS D'AMORTISSEURS // SUPPORTI AMMORTIZZATORI // // // //

Part # Nummer Numéro Codice	Description	Beschreibung	Description	Descrizione
VTR231023	Chassis: Hal	Chassis: Hal	Châssis: Hal	Telaio: Hal
VTR234023	Shock Tower, Fr/Rr: Hal	Dämpferbrücke, v/h: Hal	Support d'amortisseur Av/arr: Hal	Supporto ammortizzatore, anter/poster: Hal

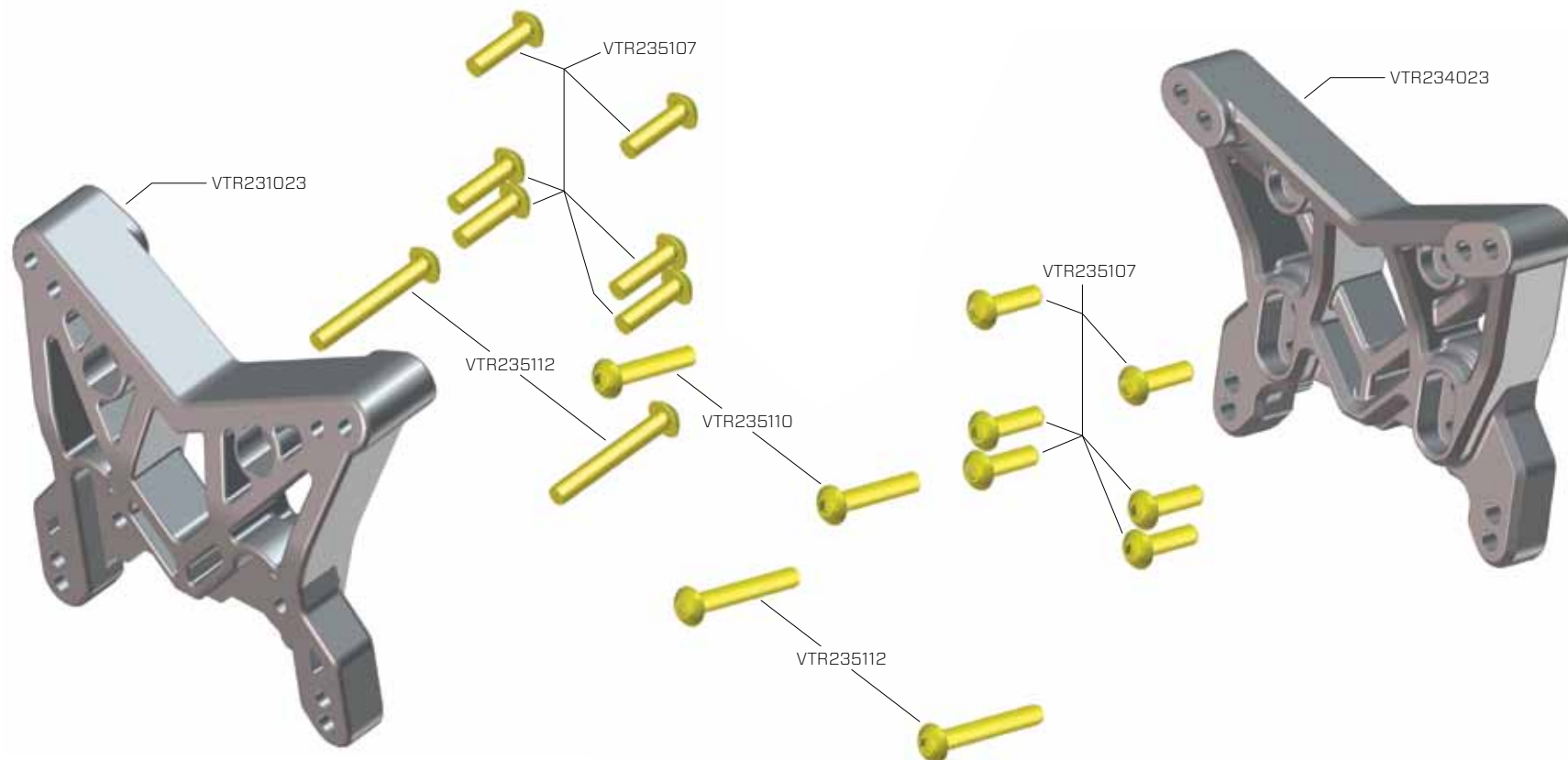

BODY MOUNTS // KAROSSERIEHALTER // SUPPORTS DE CARROSSERIE // SUPPORTI CARROZZERIA //

Part # Nummer Numéro Codice	Description	Beschreibung	Description	Descrizione
VTR231018	Body Mount, Fr/Rr: Hal	Karosseriehalter, v/h: Hal	Support de carrosserie Av/arr: Hal	Supporto carrozzeria, anter/poster: Hal
VTR246004	Body Clip, 6mm (10): GLU	Karosserieklammern 6mm (10): GLU	6mm clips à carrosserie (10): GLU	Clips 6mm per carrozzeria (10): GLU

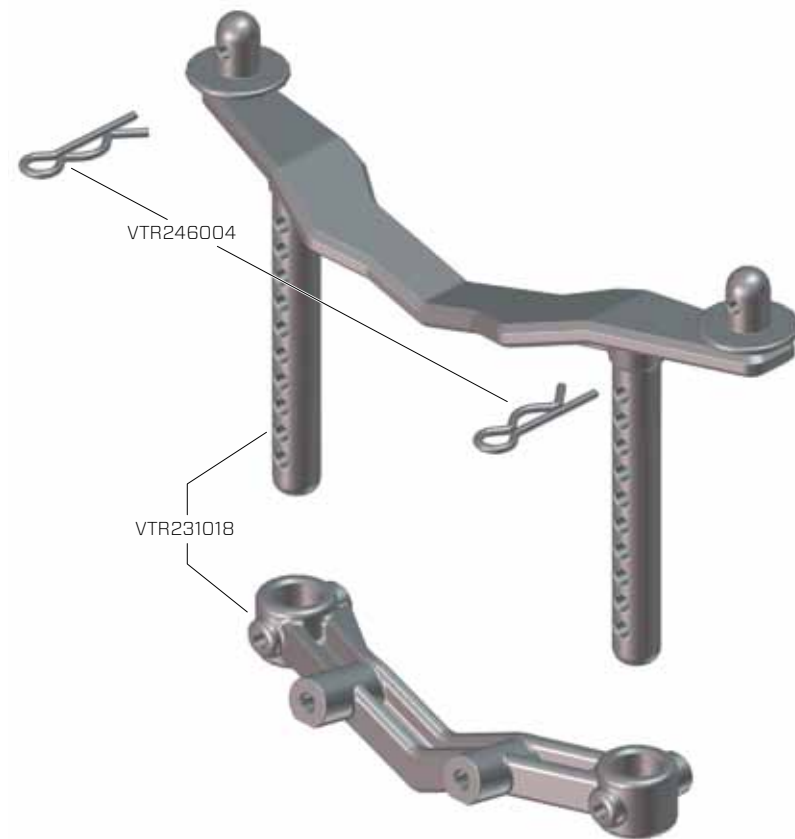
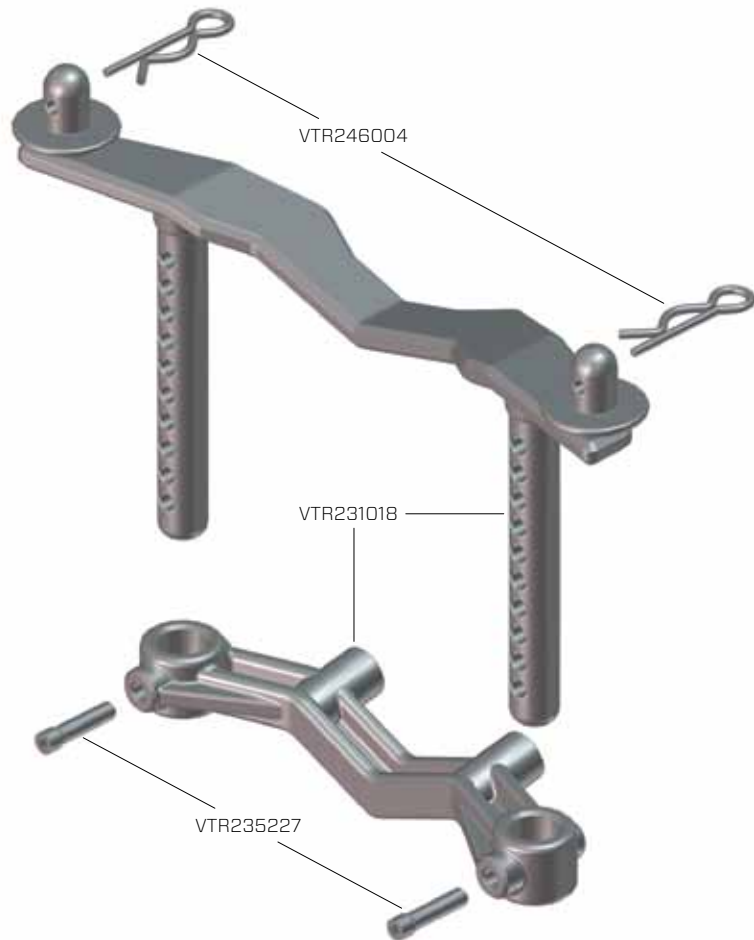

FRONT BUMPER // STOSSFÄNGER VORNE // PARE-CHOC AVANT // PARAUTI ANTERIORE ///

Part # Nummer Numéro Codice	Description	Beschreibung	Description	Descrizione
VTR231030	Bumper & Support, Fr/Rr: Rap	Stoßfänger und Halter, v/h: Rap	Pare-choc Av/arr avec support: Rap	Paraurti e supporto anter/poster: Rap



FRONT DIFFERENTIAL // FRONT DIFFERENTIAL // DIFFÉRENTIEL AVANT // DIFFERENZIALE ANTERIORE //

Part # Nummer Numéro Codice	Description	Beschreibung	Description	Descrizione
VTR232049	Complete Differential Set FR/RR	Diff Komplettsset Vorne/Hinten	Différentiel complet AV/ARR	Set differenziale completo FR/RR
VTR232054	Driveshaft (2), Fr/Rr: Hal	Antriebswelle (2) v/h: Hal	Cardan Av/arr (2): Hal	Trascinatori (2), anter/poster: Hal
VTR232056	Metal Bevel Gear & Pinion: Hal, V100	Stirnrad Metall + Ritzel: Hal, V100	Couronne et pignon coniques en métal: Hal, V100	Coppia conica in metallo & pignone: Hal, V100

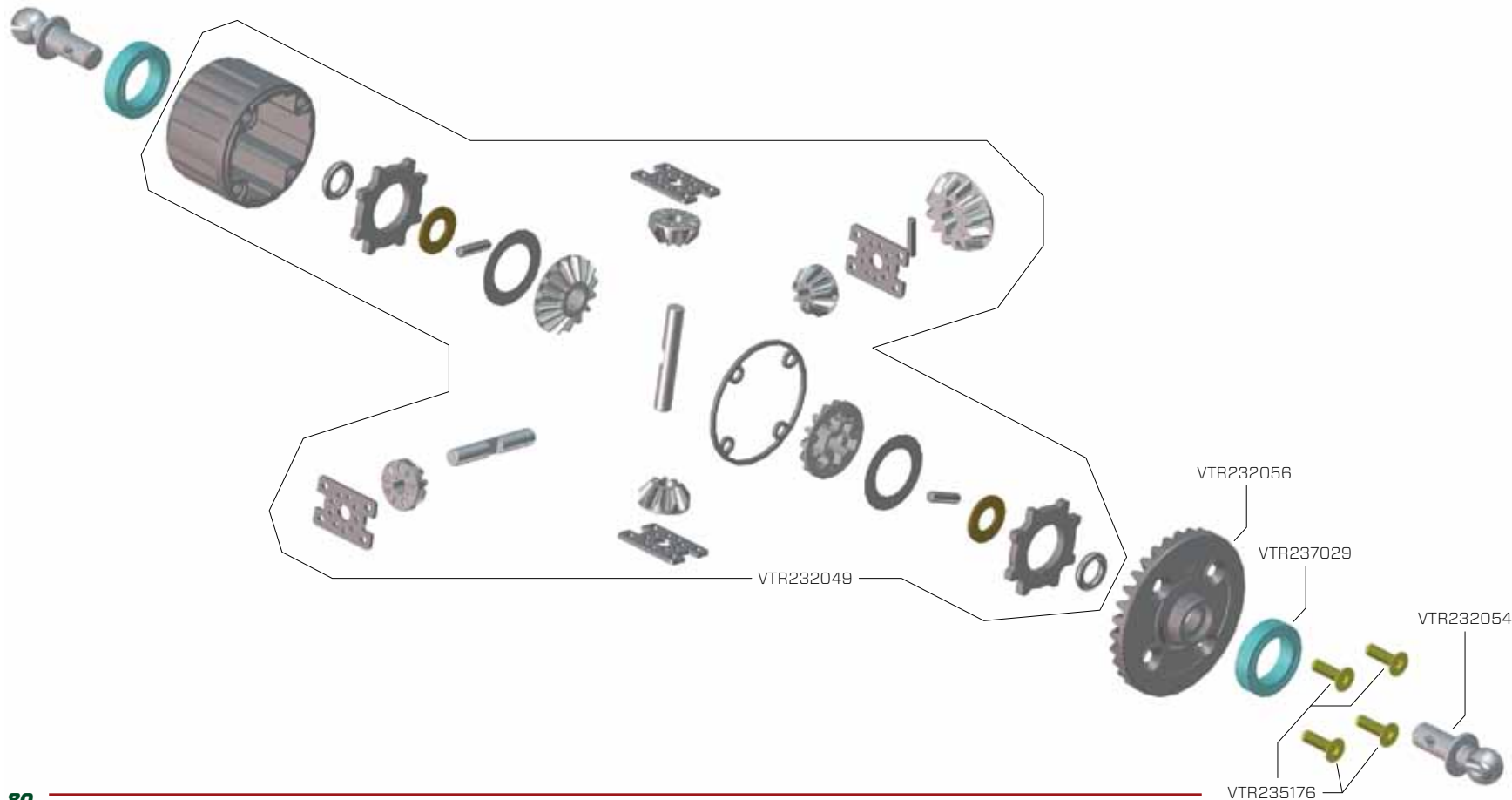

SLIPPER CLUTCH // RUTSCHKUPPLUNG // SLIPPER // FRIZIONE ANTISALTELLAMENTO //////////////////////////////////////

Part # Nummer Numéro Codice	Description	Beschreibung	Description	Descrizione
VTR232055	Slipper Hub, Spring, Shaft: Hal	Welle u. Feder Rutschkupplung: Hal	Moyeux, ressort et axe de slipper: Hal	Mozzo, molla e albero slipper: Hal
VTR232063	Slipper Cover/Spacers & Bearing Holders: Rap	Abdeckung Rutschkupplung, Distanzstück u. Lager, Halter: Rap	Couvercle, entretoise et support de roulement de slipper: Rap	Copertura, distanziale e supporti cuscinetti slipper: Rap
VTR242003	Spur Gear, 87T: GLU	Hauptzahnrad, 87T: GLU	Couronne 87T: GLU	Corona 87T: GLU
VTR242012	Slipper Disk (2): GLU	Slipper Disk (2): GLU	Plateaux de slipper (2): GLU	Disco slipper (2): GLU
VTR242013	Slipper Pad (2): GLU	Slipper Pad (2): GLU	Garnitures de slipper (2): GLU	Slipper pad (2): GLU



STEERING // LENKUNG // DIRECTION // STERZO //////////////////////////////////////

Part # Nummer Numéro Codice	Description	Beschreibung	Description	Descrizione
VTR231026	Servo Arms & Bellcranks: Hal	Servoarm u. Lenkhebel: Hal	Bras de servo et renvois de direction: Hal	Bracci servo & squadrette: Hal
VTR234007	Pushrod Pivot Balls & Pins: TWH	Gestänge Kugelköpfe und Pins: TWH	Rotules et axes de fixation d'amortisseur: TWH	Sfere comandi & perni: TWH
VTR241005	Steering Rod Ends, 4.8mm: GLU	Kugelpfannen für Lenkung 4.8mm: GLU	Chapes de direction 4,8mm: GLU	Snodi sterzo, 4,8mm: GLU
VTR246002	Ball Stud, 4.8mm x 12mm (10): GLU	Kugelkopf Set, 4,8 x12mm (10): GLU	Rotules 4.8mm x 12mm (10): GLU	Attacco a sfera, 4.8mm x 12mm (10): GLU

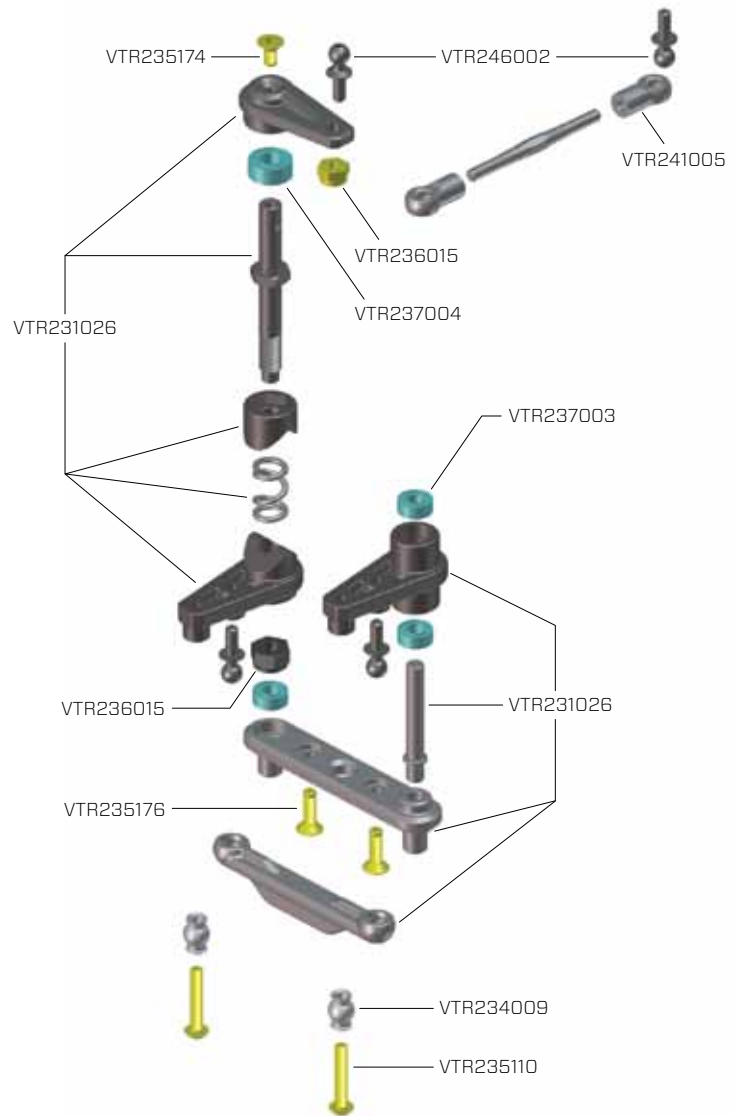

**FRONT GEARBOX // GETRIEBEGEHÄUSE VORNE // BOÎTE DE TRANSMISSION AVANT //////////////////////////////////////
 SCATOLA INGRANAGGI ANTERIORE**

Part # Nummer Numéro Codice	Description	Beschreibung	Description	Descrizione
VTR231021	Hinge Pin Brace, Fr/Rr: Hal	Querlenkerstifthalter, v/h: Hal	Renfort de cellule Av/arr: Hal	Supporto perno cerniera, anter/poster: Hal
VTR231027	Bulkhead, Fr/Rr: Hal	Chassishalter v/h: Hal	Cellule Av/arr: Hal	Paratia, anter/poster: Hal
VTR231029	Skid Plate, Fr/Rr: Rap	Unterfahrschutz Chassis v/h: Rap	Plaque de protection inférieure Av/arr: Rap	Piastra protezione, anter/poster: Rap
VTR232058	Shaft, Bevel Gear: Hal	Stirnrad u. Welle: Hal	Axe de pignon d'attaque: Hal	Albero, coppia conica: Hal

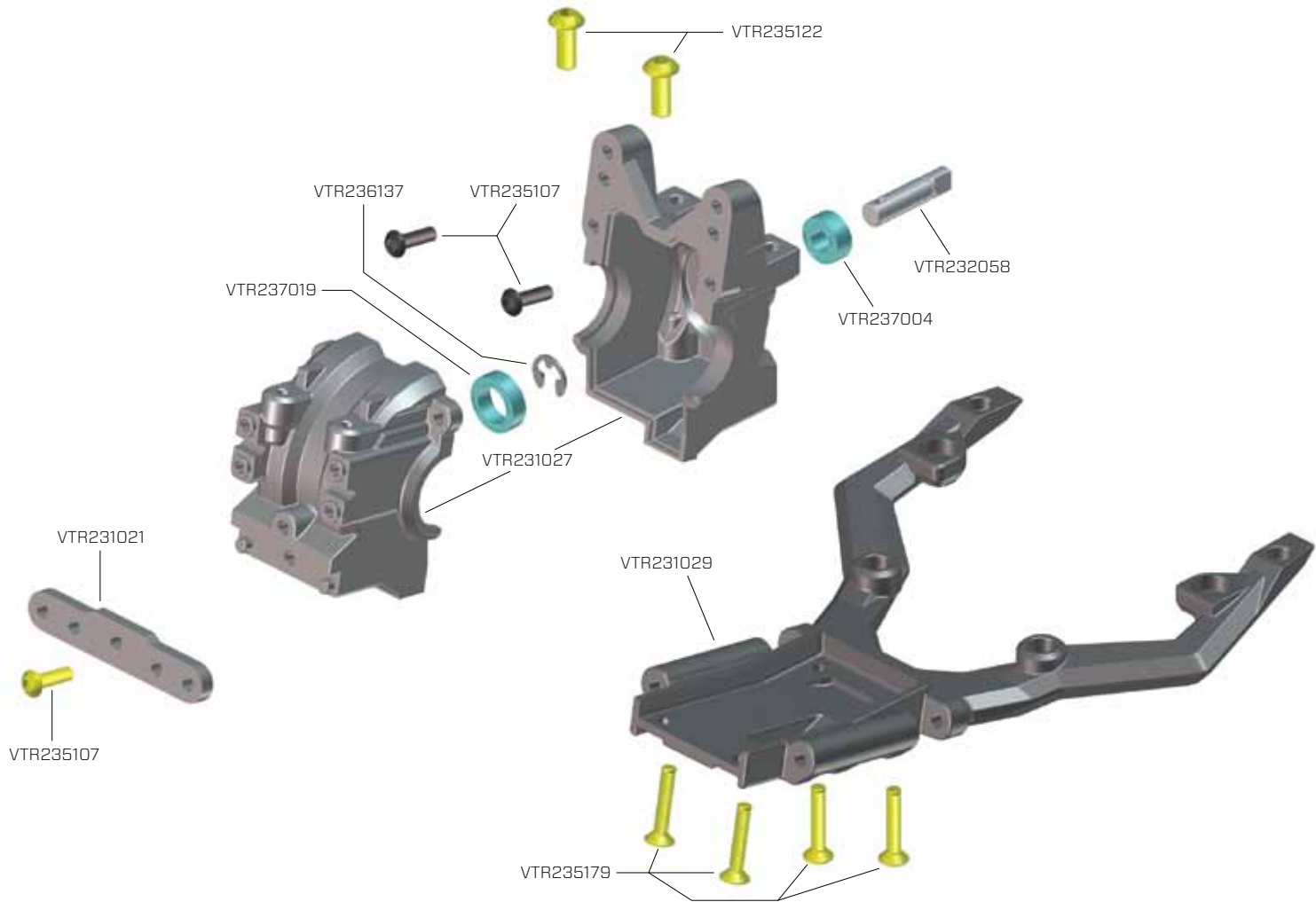

FRONT SUSPENSION // FRONT AUFHÄNGUNG // SUSPENSION AVANT // SOSPENSIONE ANTERIORE //////////////////////////////////////

Part # Nummer Numéro Codice	Description	Beschreibung	Description	Descrizione
VTR231019	Camber & Steering Links: Hal	Spur- u. Sturzstangen: Hal	Biellettes de carrossage et de direction: Hal	Collegamenti camber & sterzo: Hal
VTR232054	Driveshaft (2), Fr/Rr: Hal	Antriebswelle (2) v/h: Hal	Cardan Av/arr (2): Hal	Albero trasmissione (2), anter/poster: Hal
VTR232057	Pin & Stopper Ring: Hal	Pin u. Stopper Ring: Hal	Goupille et anneau de retenue: Hal	Perno & anello di fermo: Hal
VTR233016	Shock Body & Guard, Fr/Rr: Hal	Stoßdämpfergehäuse u. Schutz: Hal	Corps d'amortisseur Av/arr et protection: Hal	Corpo ammortizzatore e protezione, anter/poster: Hal
VTR234007	Pushrod Pivot Balls & Pins:TWH	Kugelkopf u. Stifte: TWH	Rotules et axes de fixation d'amortisseur: TWH	Sfere snodi aste comando & perni: TWH
VTR234020	Suspension Arms (2), Fr/Rr: Hal	Querlenker v/h: Hal	Triangle de suspension Av/arr (2): Hal	Bracci sospensioni (2), anter/poster: Hal
VTR234021	Castor Blocks & Spindles: Hal	Achsschenkelträger: Hal	Etriers porte fusées et fusées: Hal	Blocchi mobili & fusi: Hal
VTR242019	Hex Adapter, 12mm x 6mm: GLU	Radmitnehmer 12mm x 6mm: GLU	Hexagone 12 x 6mm: GLU	Adattatore esagonale 12 x 6mm: GLU
VTR246012	Hinge Pin, 3mm x 63.5mm (2): Hal	Querlenkerstift, 3mm x 63.5mm (2): Hal	Axe de suspension 3mm x 63.5mm (2): Hal	Perno cerniera, 3mm x 63.5mm (2): Hal
VTR246013	Hinge Pin, 3mm x 16mm (2): Hal	Querlenkerstift, 3mm x 16mm (2): Hal	Axe de suspension 3mm x 16mm (2): Hal	Perno cerniera, 3mm x 16mm (2): Hal

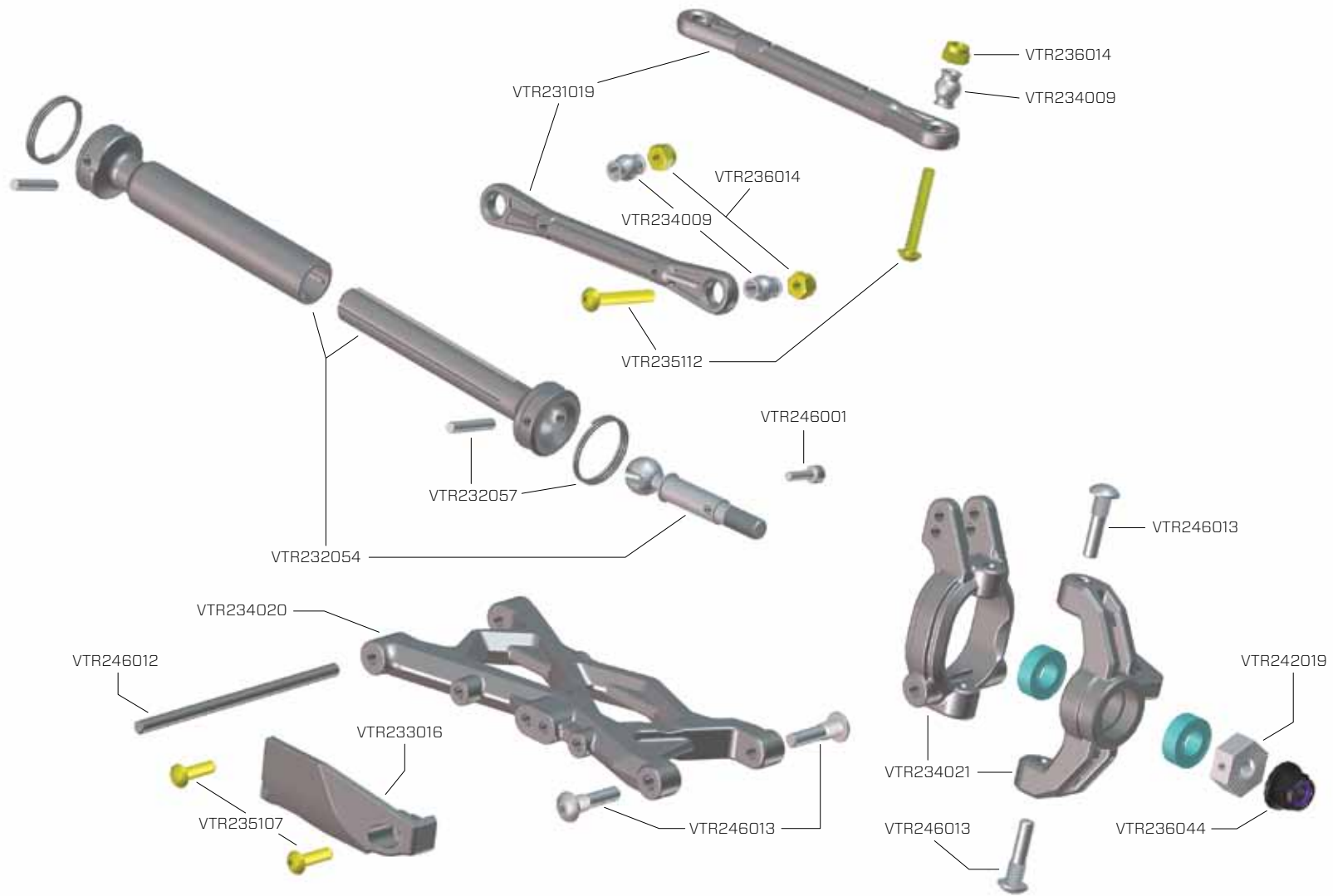

REAR SUSPENSION // HECK AUFHÄNGUNG // SUSPENSION ARRIÈRE // SOSPENSIONE POSTERIORE //////////////////////////////////////

Part # Nummer Numéro Codice	Description	Beschreibung	Description	Descrizione
VTR231019	Camber & Steering Links: Hal	Spur-u. Sturzstangen: Hal	Biellettes de carrossage et de direction: Hal	Collegamenti camber & sterzo: Hal
VTR232054	Driveshaft (2), Fr/Rr: Hal	Antriebswelle (2) v/h: Hal	Cardan Av/arr (2): Hal	Albero trasmissione (2), anter/poster: Hal
VTR232057	Pin & Stopper Ring: Hal	Pin u. Stopper Ring: Hal	Goupille et anneau de retenue: Hal	Perno & anello di fermo: Hal
VTR234020	Suspension Arms (2), Fr/Rr: Hal	Querlenker v/h: Hal	Triangle de suspension Av/arr (2): Hal	Bracci sospensioni (2), anter/poster: Hal
VTR234022	Rear Hub Carriers: Hal	Radträger hinten: Hal	Fusées arrières: Hal	Supporto mozzo posteriore: Hal
VTR242019	Hex Adapter, 12mm x 6mm: GLU	Radmitnehmer 12mm x 6mm: GLU	Hexagone 12 x 6mm: GLU	Adattatore esagonale 12 x 6mm: GLU
VTR246001	Screw Pin, Clip Post (10): GLU	Stiftschraube (10): GLU	Supports de clips avec goupilles (10): GLU	Perni viti clip (10): GLU
VTR246014	Hinge Pin, 3,2 x 40mm (2): Hal	Hinge Pin, 3,2 x 40mm (2): Hal	Axe de suspension, 3,2 x 40mm (2): Hal	Perno cerniera, 3,2 x 40mm (2): Hal

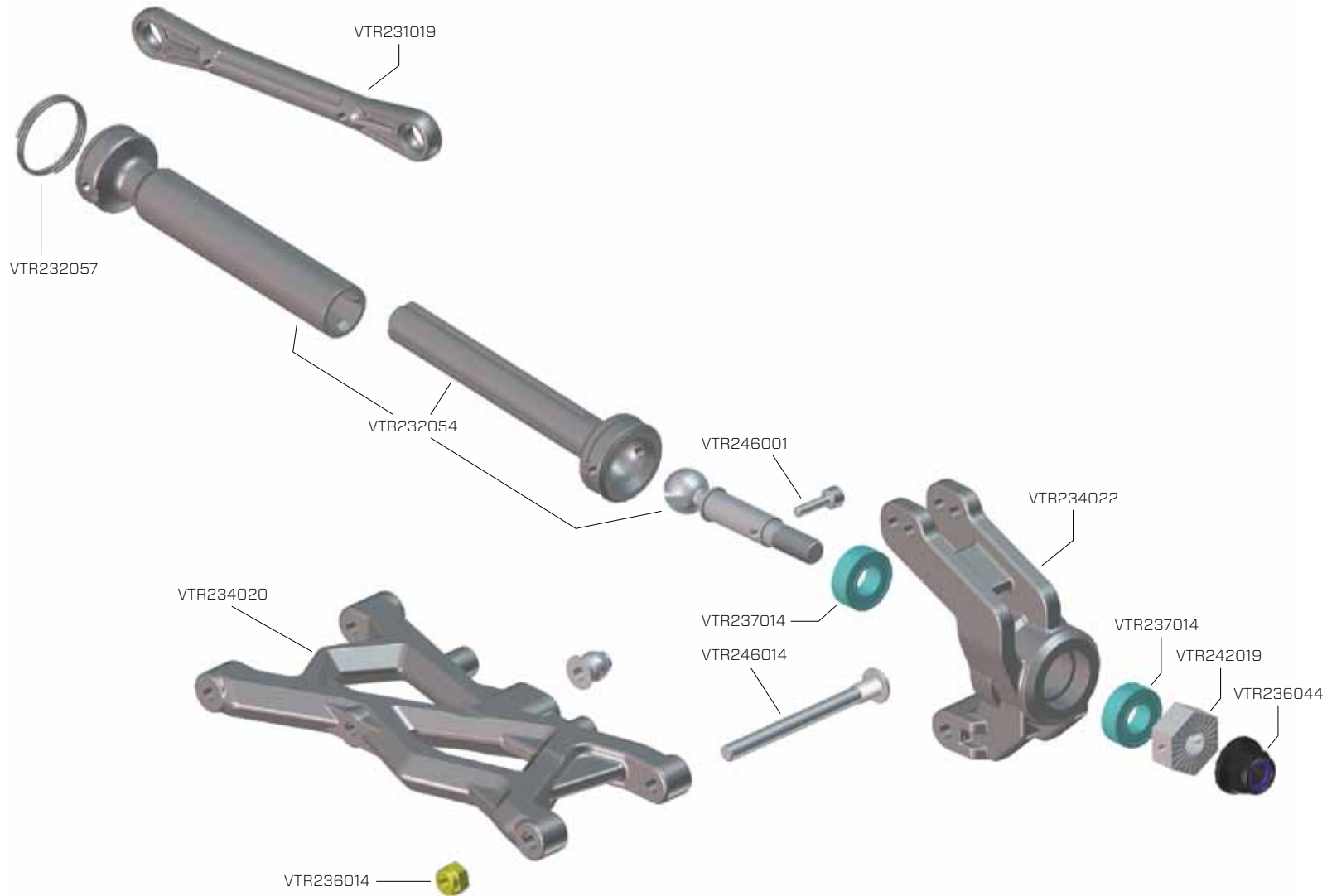

REAR BULKHEAD // CHASSISHALTER HINTEN // CELLULE ARRIÈRE // PARATIA POSTERIORE //

Part # Nummer Numéro Codice	Description	Beschreibung	Description	Descrizione
VTR231021	Hinge Pin Brace, Fr/Rr: Hal	Querlenkerhalter vorne, v/h: Hal	Etriers porte fusées et fusées: Hal	Supporto perno cerniera, anter/ poster: Hal
VTR231027	Bulkhead, Fr/Rr: Hal	Chassishalter v/h: Hal	Cellule Av/arr: Hal	Paratia, anter/poster: Hal
VTR232056	Metal Bevel Gear & Pinion: Hal, V100	Stirnrad u. Ritzel Metall: Hal	Couronne et pignon coniques en métal: Hal, V100	Coppia conica metallo & pignone: Hal, V100
VTR232058	Shaft, Bevel Gear: Hal	Welle, Stirnrad: Hal	Axe de pignon d'attaque: Hal	Albero, coppia conica: Hal
VTR232061	Slipper Cover/Spacers & Bearing Holders: Hal	Abdeckung Rutschkupplung, Lager u. Halter: Hal	Couvercle, entretoise et support de roulement de slipper: Hal	Copertura/distanziali & supporti cuscinetti slipper: Hal

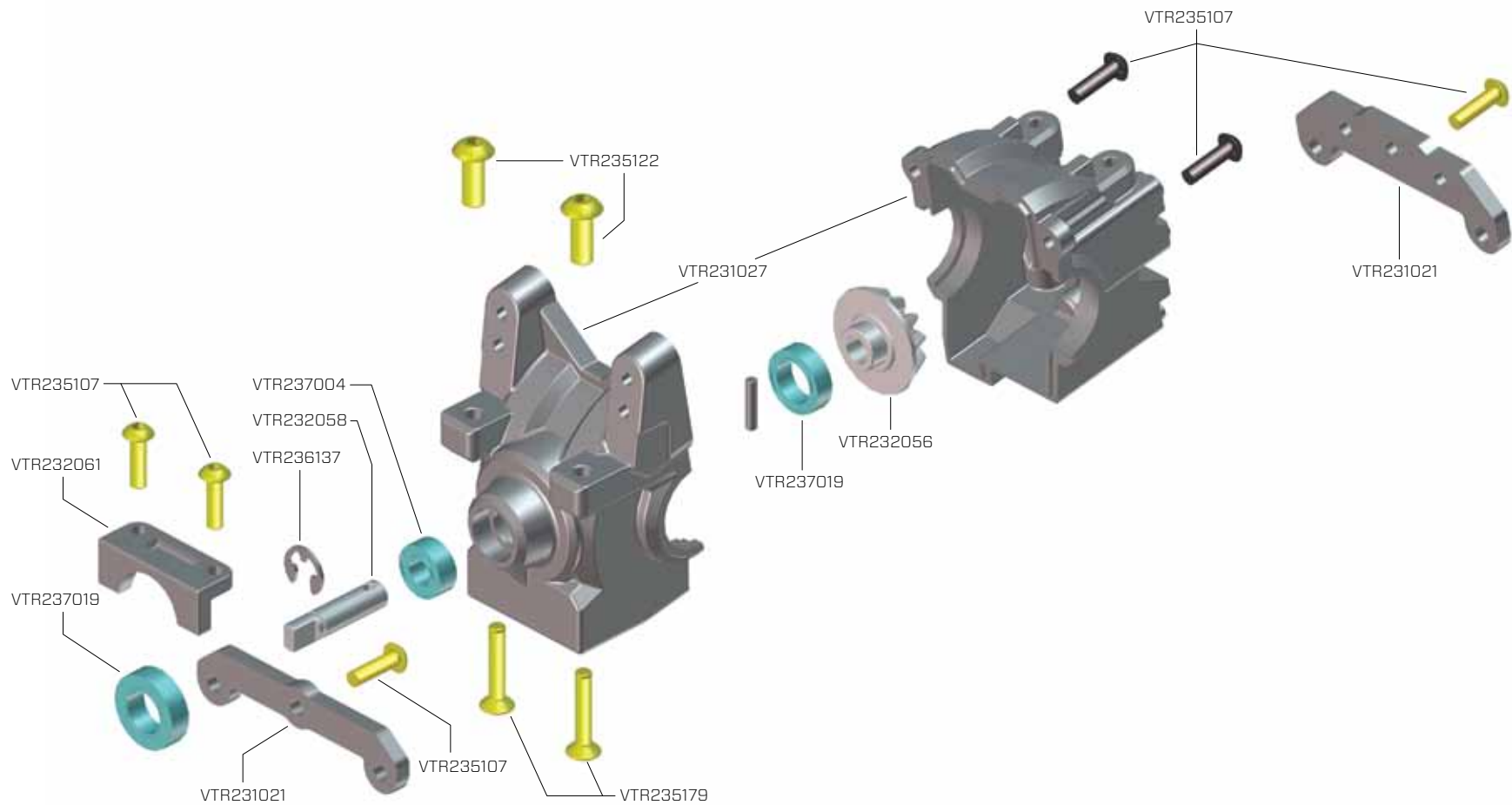

CHASSIS // CHASSIS // CHÂSSIS // TELAIO //////////////////////////////////////

Part # Nummer Numéro Codice	Description	Beschreibung	Description	Descrizione
VTR231022	Battery Foam: Hal	Schaumstoff f. Akku: Hal	Mousse pour batterie: Hal	Spugna batteria: Hal
VTR231024	Battery Strap & Pivot: Hal	Verschlussriegel f. Akku: Hal	Support de batterie avec pivot: Hal	Fermo batteria e perno: Hal
VTR231025	Receiver Mount & Cover: Hal	Empfängerhalter u. Abdeckung: Hal	Support de récepteur avec couvercle: Hal	Supporto ricevitore e coperchio: Hal
VTR231026	Servo Arms & Bellcranks: Hal	Servoarm u. Lenkhebel: Hal	Bras de servo et renvois de direction: Hal	Bracci servo & squadrette: Hal
VTR231028	Chassis: Rap	Chassis: Rap	Châssis: Rap	Telaio: Rap
VTR231029	Skid Plate, Fr/Rr: Rap	Unterfahrschutz: Rap	Plaque de protection inférieure Av/arr: Rap	Piastra protezione, anter/poster: Rap
VTR232061	Slipper Cover/Spacers & Bearing Holders: Rap	Abdeckung Rutschkupplung, Lager u. Halter: Rap	Couvercle, entretoise et support de roulement de slipper: Rap	Copertura/distanziali & supporti cuscinetti slipper: Rap
VTR232066	Center Driveshaft & Joint: Rap	Antriebswelle Mitte u. Mitnehmer: Rap	Cardan central avec noix: Rap	Trasmissione centrale & giunto: Rap
VTR246004	Body Clip, 6mm (10): GLU	Karosseriekammern 6mm (10): GLU	6mm clips à carrosserie (10): GLU	Clips 6mm per carrozzeria (10): GLU

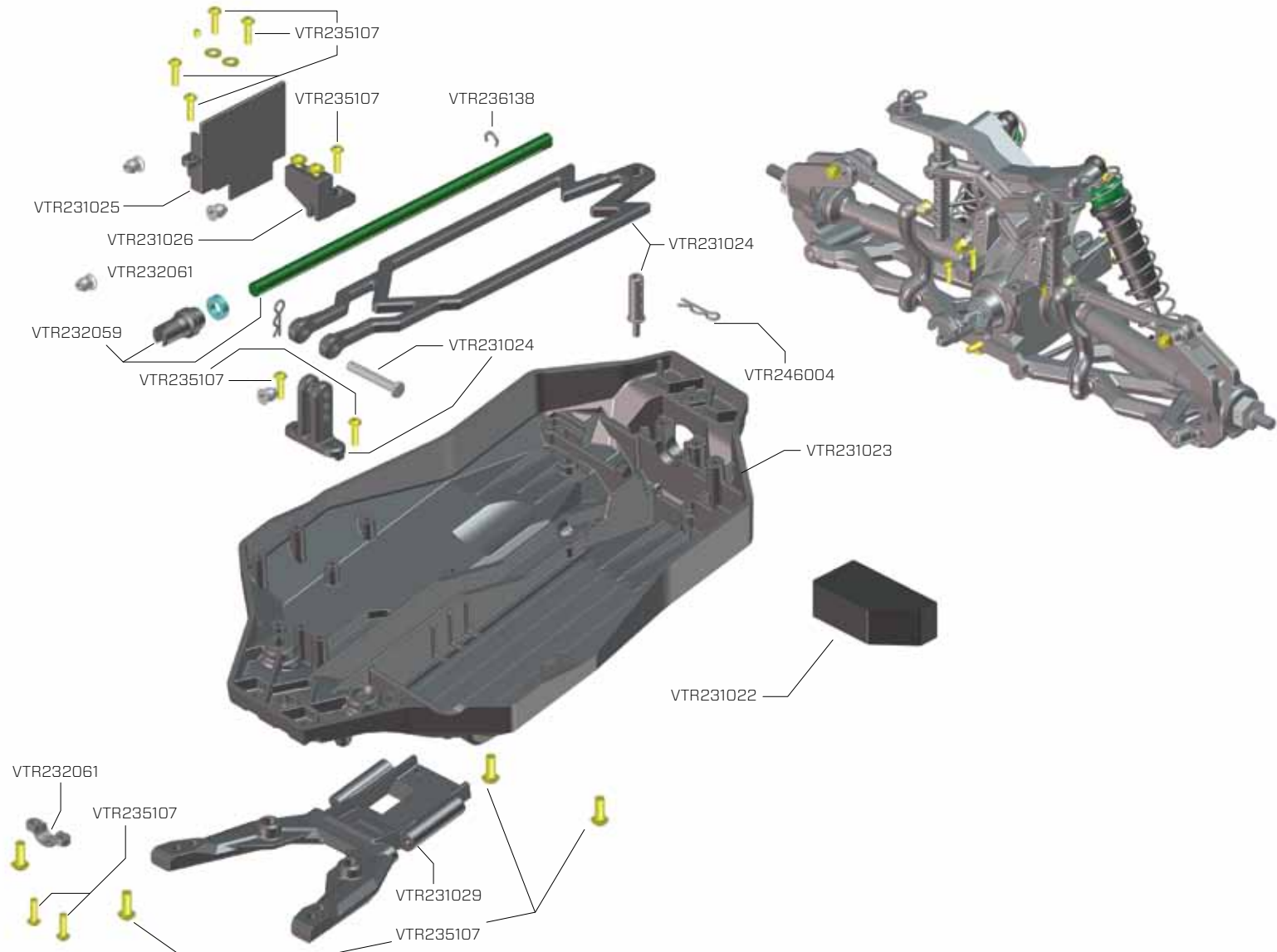

MOTOR MOUNT // MOTORTRÄGER // SUPPORT MOTEUR // SUPPORTO MOTORE //////////////////////////////////////

Part # Nummer Numéro Codice	Description	Beschreibung	Description	Descrizione
VTR232029	Pinion Gear 20T, 48P, M3 x 3 Set Screw	Ritzel 20Z, 48P, M3 x 3 Madenschraube	Pignon 20T, 48p et vis M3 x 3	Pignone 20T, 48P, M3x3 Set viti
VTR232064	Motor Mount: Rap	Motorträger: Rap	Support moteur: Rap	Supporto motore: Rap
VTR232065	Slipper Cover: Rap	Abdeckung Rutschkupplung: Rap	Couvercle de slipper : Rap	Carter slipper: Rap

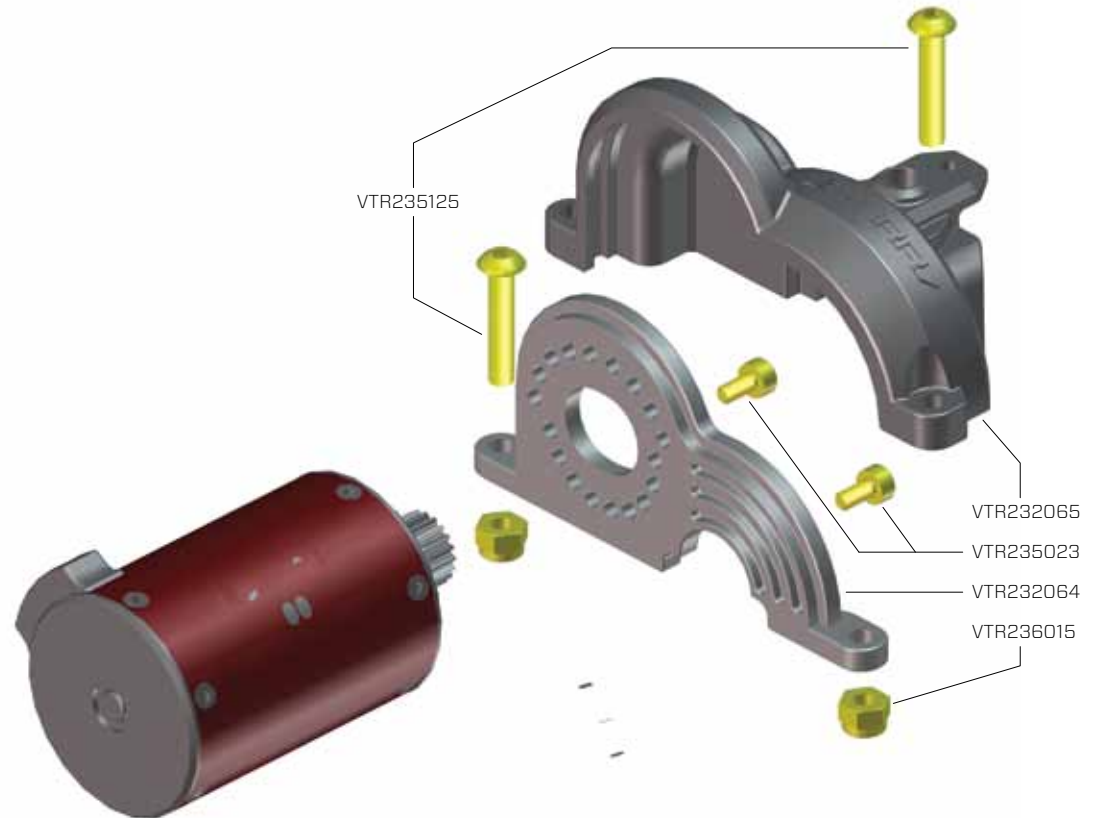

OPTIONAL PARTS // OPTIONALE BAUTEILE // PIÈCES OPTIONNELLES // COMPONENTI OPZIONALI //

Part # Nummer Numéro Codice	Description	Beschreibung	Description	Descrizione
VTR44005	Front Tire, Ribbed w/Foam, Soft, 40mm(2)	Reifen vorne m. Schaumeinlage, oft 40mm (2)	Pneus avant lignés avec insert, souple, 40mm (2)	Gomma anter., ribbed c/espanso, morbida, 40mm(2)
VTR44006	Rear Tire, Tetrapod w/Foam, Soft, 50mm (2)	Reifen hinten m. Schaumeinlage Soft 50mm (2)	Pneus arrière Tetrapod avec insert, souple, 50mm (2)	Gomma anter., tetrapod c/espanso, morbida, 50mm(2)
VTR230024	Body, Clear: Rap	Karosserie, Transparent: Rap	Carrosserie transparente: Rap	Carrozzeria trasparente: Rap
VTR230025	Body, Painted: Rap	Karosserie lackiert : Rap	Carrosserie peinte : Rap	Carrozzeria, verniciata: Rap
VTR340000	Light Set w/Buckets	Beleuchtung	Kit d'éclairage avec reflecteurs	Set luci c/riflettori
VTR343000	Front Aluminum Shock Set (2), 95mm	Aluminium Stoßdämpferset vorne (2) 95mm	Amortisseurs avant en aluminium (2), 95mm	Set ammortizz. anter. alluminio (2), 95mm
VTR343001	Rear Aluminum Shock Set (2), 114mm	Aluminium Stoßdämpferset hinten e (2) 114mm	Amortisseurs arrière en aluminium (2), 114mm	Set ammortizz. poster. alluminio (2), 114mm
VTR344000	Sway Bar Set	Querstabilisator Set	Jeu de barres anti-roulis	Set barra oscillante



VATERRA®

It is a shared passion for motorsports and radio control. Extreme performance and extreme places. Cars and trucks that look and drive just like the real thing. Most of all, it is about gathering friends, grabbing a vehicle and having the time of your life.

Adventure Driven.™